

**KuDos**<sup>®</sup>  
Professional Hydraulic Tools.





## ■ ISO 9001:2008

Certificate No: TA254-QC-EC



## ■ ISO 14001: 2004

Certificate No: TA254-QC-EC

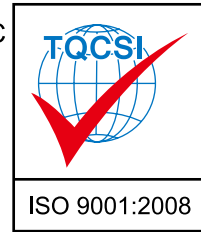

## ■ IECQ QC 080001

Certificate No: TW-HSPM-1237-1



## ■ OHSAS 18001:2007

Certificate No: 2008006



## ■ UVDB

Supplier Number: 184603



KuDos<sup>®</sup> Professional Hydraulic Tools are carefully inspected for quality and tested for safety.

We comply with ISO 9001 : 2008,  
ISO 14001 : 2004, IECQ QC 080001,  
OHSAS 18001 : 2007, UVDB.



## Professional Electric & Electronic Tool Hand Tools



Cable Cutters	8~9
Rod & Wire Cutters	9
Ratchet Cable Cutters	10
Automatic Wire Stripper	11
Rotary Cable Strippers	11
Cable Tie Tensioning Tools	12
Ratchet Control Crimping Tools	13~16
Professional Modular Tools	16
Deluxe Modular Tools	16~17
Die For HD-8" Frame	18~19
Die For RG-9" Frame	20~21
Die For HD-9" Frame	22
Punch Down Tool	22
Heavy Duty Crimping Tools	23~24

**▲ Cutting of XLPE cable and steel wire are prohibited.**

## Battery Operated Tools



Close View of NEW LEC series Features	25	REC-54AC	52
LEC-25(Die Set)	26~27	LEC-54AC	53
LEC-185T	28	REC-65	54
LEC-240T	29	LEC-65	55
LEC-U26	30	REC-85CCP	56
LEC-U27	31	Close View of NEW KC series Features	57
LEC-150	32	KC-54	58
LEC-32	33	KC-54AC	59
LEC-40	34	KC-50	60
LEC-44	35	Close View of NEW K series Features	61
LEC-45X(Related heads)	36~37	K-50(Die Set)	62~63
LEC-240	38	K-150	64
LEC-U240	39	K-BGD3	65
LEC-6FT	40	K-10C	66
LEC-6	41	K-120	67
LEC-S24	42	K-ED10	68~69
LEC-S45	43	K-185	70
LEC-S55	44	K-240	71
LEC-C85	45	K-PH240	72
LEC-30A	46	K-20	73
LEC-85YC	47	K-24	74
REC-50	48	K-S24	75
LEC-50	49	K-30A	76
REC-54	50	Batteries & Chargers	77
LEC-54	51		

## Hydraulic Cutters



Cutting Capacity Chart	78
HYSC-20	79
HYSC-24	80
S-24	81
HYSC-32	82
HYSC-45	83
HYCC-050	84
S-55	85
HYCC-P85	86
TC-085	87
PC-8511	88
YS-30A	89
HYCC-85YC	90
HYSC-20HE	91
HYSC-24HE	92
S-24HE	93
HYSC-32HE	94
HYSC-45HE	95
HYCC-35HE	96
HYCC-050HE	97
S-55HE	98
HYSC-55HE	99
HYCC-P85HE	100
TC-085HE	101
HYCC-P100HE	102
HYCC-105HE	103
TC-120HE	104
YS-30AHE	105
HYCC-065HE	106
HYCC-075S	107
HYCC-096S	108
P-85YC	109

## Hydraulic Crimpers



Compression Capacity Chart	110
HH-400 (HH-400I / HH-400X / HH400XL)	111
9H-150	112
HYCP-185	113
HYCP-240	114
PH-240	115
UCP-240	116
UCP-2613	117
UB-400	118
UB-400C	119
UCP-2712	120
UC-6FT	121
UB-412	122
UB-412C	123
HYCP-4413	124
HYCP-4413C	125
UC-6	126
UC-6C	127

## Compression Head

	Compression Capacity Chart	128
	HH-400HE	129
	9H-150HE	130
	HYCP-185HE	131
	HYCP-240HE	132
	PH-240HE	133
	UCP-240HE	134
	UB-400HE	135
	UCP-2712HE	136
	UB-412HE / H-412HE	137
	HYCP-4413HE	138
	UC-6FTHE / UC-6HE	139
	HYCP-15THE / ADP-15THE	140
	HYCP-630HE / ADP-630HE	141
	HYCP-451000HE / ADP-451000HE	142
	HYCP-500HE	143
	HYCP-60ST	144
	HYCP-60D	145
	UA-100STS	146
	UA-100ST	147
	SR-100C / HYCP-100ST	148
	100W	149
	200W	150
	Crimpers Dies / Die Case	151~160

## Hydraulic Punchers & Benders

	DRCP-559140	161
	PNST-10 / PNST-10M	162
	Accessories	163
	PN-052 / PN-052M	164
	PN-254	165
	SH-70A	166
	HYBC-120	167
	BC160-27	168
	ASC-7510	169
	HDBC-16	170
	HYBN-120 / DBBN-120	171
	HYBN-160	172

## Hydraulic Pipe Bender

	PB-10N	173
	Pipe Bender	174

## Hydraulic Nut Splitter

	HYNC-Series	175~177
	PF-1319	178
	PF-2432	179



## Hydraulic Pumps

Pumping Capacity Chart	180
HP-180N	181
HYP-700FT	182
HYP-700FTG	183
HP-700A	184
HP-700AG	185
HF-700	186
HF-700G	187
HP-30S	188
HP-30MD	189
CEP-15SS	190~191
EP-30MS	192
EP-30MD	193
EP-30S	194
EP-76MS	195
EP-76MD	196
EP-76SD	197
EP-76SS	198
EP-76SSC	199
GHP-5	200
GHP-5W	201
GHP-5SD	202
GHP-5SDRM	203
EP-200SD	204
EP-200SDCF	205
EP-200MD	206
EP-200NDCF	207



## Hydraulic Puller

UK-6	208
UK-6HE	209
UK-8	210
UK-8HE	211
UK-12	212
UK-12HE	213
UK-12L	214
UK-12LHE	215



## Accessories

Hose Quick Coupler	216
Gauge	217
Packaging	218~222



## Others

Company Store	223~225
Approximate Conversion	226
Crimping Instruction	227
Memo	228

# Warranty

## Limited Lifetime Warranty (A)

- Kudos' Hydraulic products are warranted against defects in material and workmanship for the life of the product. This is defined as that point in time that point in time when the product no longer functions due to normal wear under one year warranty.
- This warranty is subject to the following exclusions and limitations:
  1. This warranty does not cover damages to products which are not installed, operated, Used and maintained used and maintained in accordance with writdisassembly of otherwise altered, or from disassembly or attempted disassembly by parties other than KuDos or its authorized service representatives.
  2. This warranty does not cover products that have been worn out, damaged by improper storage, damaged or otherwise altered, or from disassembly or attempted disassembly by parties other than KuDos or its authorized service representatives.
  3. This warranty does not cover damages caused by the use of components not manufactured or authorized by KuDos, acts of God, accidents, use in a manner for which they are not intended.
- KuDos' liability in all cases is limited to, and shall not exceed, the purchase price paid. Kudos shall not be liable to any buyer for consequential or incidental damages of any kind.
- Batteries, chargers, electric motors, gasoline engines and cutting blades sold with Kudos products and not covered by this warranty.  
All electric motors and gas engines are seperately warranttd by the manufacturers.
- Receipt and warranty card are required for warranty services.
- If the tool is found to be defective, in our sole judgment, Kudos will either repair or replace the defective product or part.
- All revisions in warranty policy and product informations will be included in future versions of our from manuals. Copies of this warranty are available from the factory upon request.

## Limited Lifetime Warranty (B)

- Kudos electronic products are warranted against defects in material and workmanship for one year.
- This warranty is subject to the following exclusions and limitations:
  1. This warranty does not cover damages to products which are not installed, operated, used and maintained in accordance with written instructions.
  2. This warranty does not cover products that have been worn out, damaged by improper storage, damaged or otherwise altered, or from disassembly or attempted disassembly by parties other than Kudos or its authorized service representatives.
  3. This warranty does not cover damages caused by the use of components not manufactured or authorized by KuDos, acts of God, accidents, use in a manner for which they are not intended.
- KuDos' liability in all cases is limited to, and shall not exceed, the purchase price paid. Kudos shall not be liable to any buyer for consequential or incidental damages of any kind.
- Batteries, chargers, electric motors, gasoline engines and cutting blades sold with Kudos products and not covered by this warranty.  
All electric motors and gas engines are seperately warranttd by the manufacturers.
- Receipt and warranty card are required for warranty services.
- If the tool is found to be defective, in our sole judgment, Kudos will either repair or replace the defective product or part.
- All revisions in warranty policy and product informations will be included in future versions of our from manuals. Copies of this warranty are available from the factory upon request.



## ■ Model No. **CC-08**

CUT ROUND CABLE AND WIRE  
MULTI-CONDUCTOR  
CABLE UP TO .500", COAXIAL CABLE UP TO  
RG-9/U, STRANDED WIRE UP TO 10 SQ.MM.  
#8 AWG.  
LENGTH: 165 MM  
WEIGHT: 0.15 KGS



## ■ Model No. **CC-22**

FOR COPPER AND ALUMINUM CABLE UP TO 25  
SQ.MM. #4 AWG.  
LENGTH: 165 MM  
WEIGHT: 0.19 KGS



## ■ Model No. **CC-38S**

FOR COPPER AND ALUMINUM CABLE UP TO 38  
SQ.MM. #2 AWG.  
LENGTH: 210 MM  
WEIGHT: 0.30 KGS



## ■ Model No. **CC-38**

FOR COPPER AND ALUMINUM CABLE UP TO 38  
SQ.MM. #2 AWG.  
LENGTH: 210 MM  
WEIGHT: 0.30 KGS



## ■ Model No. **CC-60**

FOR COPPER AND ALUMINUM CABLE UP TO 60  
SQ.MM. AWG 1/0.  
LENGTH: 235 MM  
WEIGHT: 0.38 KGS



## ■ Model No. **CC-80**

FOR COPPER AND ALUMINUM CABLE UP  
TO 80 SQ.MM. AWG 3/0  
LENGTH: 320 MM  
WEIGHT: 0.73 KGS



## ■ Model No. **CC-250**

FOR COPPER AND ALUMINUM CABLE UP  
TO 250 SQ.MM. AWG 500 MCM.  
LENGTH: 600 MM  
WEIGHT: 1.54 KGS



## ■ Model No. **CC-500**

FOR COPPER AND ALUMINUM CABLE UP  
TO 500 SQ.MM. AWG 1000 MCM.  
LENGTH: 800 MM  
WEIGHT: 2.93 KGS



# CABLE CUTTERS

## ■ Model No. **CC-185**

FOR COPPER AND ALUMINUM CABLE UP TO 185 SQ.MM. AWG 350 MCM.  
COMPOUND HANDLES DESIGN,  
EASY CUTTING.  
LENGTH: 600 MM  
WEIGHT: 1.80 KGS



## ■ Model No. **CC-400LT**

FOR COPPER AND ALUMINUM CABLE UP TO 400 SQ.MM. AWG 800 MCM  
COMPOUND HANDLES DESIGN, EASY CUTTING.  
ALUMINUM TUBE HANDLES  
LENGTH: 700 MM  
WEIGHT: 1.57 KGS



# ROD AND WIRE CUTTERS

## ■ Model No. **SCC-4**

FOR WIRE ROPE: 4 MM MAX.  
SPRING WIRE: 1.5MM MAX.  
LENGTH: 190 MM  
WEIGHT: 0.28 KGS



## ■ Model No. **SCC-60**

FOR STEEL ROD: 5MM MAX.  
WIRE ROPE: 7MM MAX.  
COPPER CABLE: 60 SQ.MM. AWG 1/0 MAX.  
LENGTH: 310 MM  
WEIGHT: 0.73 KGS



## ■ Model No. **SCC-200**

FOR STEEL ROD: 9MM MAX.  
WIRE ROPE: 12MM MAX.  
COPPER CABLE: 150 SQ.MM. AWG 300 MCM MAX.  
LENGTH: 600 MM  
WEIGHT: 1.80 KGS



## ■ Model No. **RCC-325**

FOR COPPER AND ALUMINUM CABLE  
UP TO 325 SQ.MM.  
AWG 600 MCM.  
LENGTH: 250 MM  
WEIGHT: 0.65 KGS



## ■ Model No. **RCC-300**

FOR COPPER AND ALUMINUM CABLE  
UP TO 300SQ.MM. AWG 600 MCM  
LENGTH: 280 MM  
WEIGHT: 0.75 KGS



## ■ Model No. **RCC-500**

FOR COPPER AND ALUMINUM CABLE  
UP TO 500 SQ.MM. AWG 1000 MCM.  
LENGTH: 285 MM  
WEIGHT: 0.85 KGS



## ■ Model No. **RCC-325PH**

FOR COPPER AND ALUMINUM  
CABLE UP TO 380 SQ.MM.  
AWG 750 MCM.  
LENGTH: 290 MM  
WEIGHT: 0.99 KGS



## ■ Model No. **RCC-500PH**

TELCO CUTTER CUTS UP TO  
2700 PAIRS CABLE.  
LENGTH: 350 MM  
WEIGHT: 1.29 KGS



# AUTOMATIC WIRE STRIPPER

## ■ Model No. TP-700A

FOR STRIPPING WIRE AWG 14, 16, 18, 24.  
SINGLE WIRE - 2.0, 1.6, 1.2, 0.5 $\phi$ MM.  
MULTIPLE WIRES - 3.5, 2.0, 1.3, 0.2MM<sup>2</sup>  
LENGTH: 170 MM  
WEIGHT: 0.34 KGS



## ■ Model No. TP-700B

FOR STRIPPING WIRE AWG 10, 12, 14, 16, 20.  
SINGLE WIRE - 6, 4, 2.5, 1.6, 0.5 $\phi$ MM.  
MULTIPLE WIRES - 8.0, 5.5, 3.5, 2.0, 0.8MM<sup>2</sup>  
LENGTH: 170 MM  
WEIGHT: 0.34 KGS



# ROTARY CABLE STRIPPERS

## ■ Model No. RCS-0425

FOR CABLE OUTER DIAMETER  
FROM 4 MM UP TO 25 MM $\phi$ .  
LENGTH: 136 MM  
WEIGHT: 0.15 KGS



## ■ Model No. TG-007

CABLE TIE WIDTH FROM 2.2 TO 4.8 MM.  
AUTO. CUT-OFF.  
LENGTH: 165 MM  
WEIGHT: 0.21 KGS



## ■ Model No. TG-008

CABLE TIE WIDTH FROM 2.2 TO 4.8 MM.  
AUTO CUT-OFF. MATERIAL: METAL.  
LENGTH: 160 MM  
WEIGHT: 0.30 KGS



## ■ Model No. TG-009

CABLE TIE WIDTH FROM 3.6 TO 9.0 MM.  
LENGTH: 195 MM  
WEIGHT: 0.32 KGS



## ■ Model No. TG-009NP

CABLE TIE WIDTH FROM 3.6 TO 9.0 MM.  
WITH A SAFETY PIN  
LENGTH: 195 MM  
WEIGHT: 0.33 KGS



## ■ Model No. TG-010

CABLE TIE WIDTH FROM 3.6 MM TO 13 MM.  
AUTO CUT-OFF.  
LENGTH: 200 MM  
WEIGHT: 0.32 KGS



## ■ Model No. TG-011

SEMI-AUTO MODULE ENABLE TO THE FUNCTION OF TIGHTEN AND CUT OUT THE STAINLESS STEEL TIES.  
APPLICATION AS AFTER THE STAINLESS STEEL TIE HAS BEEN TIGHTENED PUSH DOWN THE ROUND STEEL BAR AT SIDE CAN EASILY CUT OFF REST OF TIE.  
LENGTH: 217 MM  
WEIGHT: 0.56 KGS



## ■ Model No. **HD-8L**

FOR NON-INSULATED TERMINALS 1.25 TO 8 SQ.MM.  
FOR CABLE LUGS  
FROM 1.5 TO 10  
SQ.MM. AWG 22-8.  
LENGTH: 272 MM  
WEIGHT: 0.49 KGS



## ■ Model No. **HD-16L**

FOR NON-INSULATED TERMINALS 1.25 TO 14 SQ.MM.  
FOR CABLE LUGS  
FROM 1.5 TO 16  
SQ.MM. AWG 22-6.  
LENGTH: 275 MM  
WEIGHT: 0.52 KGS



## ■ Model No. **HD-25L**

FOR NON-INSULATED TERMINALS 5.5 TO 22 SQ.MM.  
FOR CABLE LUGS  
FROM 6 TO 25  
SQ.MM. AWG 12-4.  
LENGTH: 354 MM  
WEIGHT: 0.78 KGS



## ■ Model No. **HD-25X**

FOR CABLE LUGS FROM 6 TO 25 SQ.MM.  
HEXAGONAL PRESSURE.  
LENGTH: 354 MM  
WEIGHT: 0.78 KGS



## ■ Model No. **AK-8**

FOR NON-INSULATED TERMINALS 1.25 TO 8 SQ.MM.  
FOR CABLE LUGS  
FROM 1.5 TO 10  
SQ.MM. AWG 18-8  
LENGTH: 275 MM  
WEIGHT: 0.50 KGS



## ■ Model No. **AK-14**

FOR NON-INSULATED TERMINALS 5.5 TO 14 SQ.MM.  
FOR CABLE LUGS  
FROM 6 TO 16  
SQ.MM. AWG 10-6  
LENGTH: 355 MM  
WEIGHT: 0.84 KGS



## ■ Model No. **XLHD-0560**

FOR INSULATED TERMINALS FROM 0.5 TO 6 SQ.MM. AWG 22-18, 16-14, 12-10.  
LENGTH: 258 MM  
WEIGHT: 0.65 KGS



## ■ Model No. **XLHD-F0560**

FOR NON-INSULATED OPEN BARREL TERMINAL FROM 0.5 TO 6 SQ.MM.  
AWG 22-18, 16-14, 12-10.  
LENGTH: 258 MM  
WEIGHT: 0.65KGS



## ■ Model No. **XLHD-156**

FOR NON-INSULATED TERMINALS AND CABLE LUGS FORM 1.5 TO 6 SQ.MM.  
AWG 22-18, 16-14, 12-10.  
LENGTH: 258 MM  
WEIGHT: 0.65 KGS



## ■ Model No. **XLCLD-125**

FOR CLOSE END CONNECTOR AND WPS-WATER PROOF SPLICE FROM 1.5 TO 6 SQ.MM.  
AWG 22-18, 16-14, 12-10.  
LENGTH: 258 MM  
WEIGHT: 0.65 KGS



## ■ Model No. **XLHD-0510DN**

FOR NON-INSULATED TERMINALS DIN 46234 FROM 0.5 TO 10 SQ. MM. AWG 22-18, 16-14, 12-10 AND 8  
LENGTH: 258 MM  
WEIGHT: 0.65 KGS



## ■ Model No. **XLHD-FLAG**

FOR INSULATED FLAG TERMINALS FROM 1.5 TO 2.5 SQ.MM.  
AWG 22-18, 16-14.  
LENGTH: 258 MM  
WEIGHT: 0.65 KGS



## ■ Model No. **XLHD-SWLK**

FOR STEEL-WIRE LOCK CONNECTOR  
LENGTH: 258 MM  
WEIGHT: 0.65 KGS



## ■ Model No. **XLCE-1635**

FOR CORD END TERMINALS FROM 16 TO 35 SQ.MM. AWG 6-2.  
LENGTH: 258 MM  
WEIGHT: 0.65 KGS



## ■ Model No. **XLCE-510**

FOR CORD END TERMINALS FROM 0.5 TO 10 SQ.MM. AWG 22-8.  
LENGTH: 258 MM  
WEIGHT: 0.65 KGS



## ■ Model No. **CE-1635**

FOR CORD END TERMINALS FROM 16 TO 35 SQ.MM. AWG 6-2.  
LENGTH: 226 MM  
WEIGHT: 0.54 KGS



## ■ Model No. **CE-510**

FOR CORD END TERMINALS FROM 0.5 TO 10 SQ.MM. AWG 22-8.  
LENGTH: 225 MM  
WEIGHT: 0.49 KGS



## ■ Model No. **HD-0560**

FOR INSULATED TERMINALS FROM 0.5 TO 6 SQ.MM. AWG 22-18, 16-14, 12-10.  
LENGTH: 225 MM  
WEIGHT: 0.51 KGS



## ■ Model No. HD-F0560

FOR NON-INSULATED OPEN BARREL TERMINAL  
FROM 1.5 TO 6 SQ.MM.  
AWG 22-18, 16-14, 12-10.  
LENGTH: 225 MM  
WEIGHT: 0.51 KGS



## ■ Model No. LKT-F0560

LOCATER FOR  
HD-F0560



## ■ Model No. HD-156

FOR NON-INSULATED TERMINALS AND CABLE LUGS  
FORM 1.5 TO 6 SQ.MM.  
AWG 22-18, 16-14, 12-10.  
LENGTH: 225 MM  
WEIGHT: 0.49 KGS



## ■ Model No. HD-A228

FOR NON-INSULATED TERMINALS AWG 22-8  
LENGTH: 225MM  
WEIGHT: 0.56 KGS



## ■ Model No. HD-0510

FOR NON-INSULATED TERMINALS DIN 46234  
FROM 0.5 TO 10 SQ. MM. AWG 22-18, 16-14, 12-10 AND 8  
LENGTH: 225MM  
WEIGHT: 0.56 KGS



## ■ Model No. HD-NF 1

FOR NON-INSULATED FLAG TERMINALS  
FROM 0.5 TO 2.5 SQ.MM.  
AWG 22-18, 16-14.  
LENGTH: 225 MM  
WEIGHT: 0.56 KGS



## ■ Model No. CLD-125

FOR CLOSE END CONNECTOR AND WPS-WATER  
PROOF SPLICE FROM 1.5 TO 6 SQ.MM.  
AWG 22-18, 16-14, 12-10.  
LENGTH: 225MM  
WEIGHT: 0.56 KGS



## ■ Model No. HD-SWLK

FOR STEEL-WIRE LOCK CONNECTOR  
LENGTH: 225MM  
WEIGHT: 0.56 KGS



## ■ Model No. HD-FLAG

FOR INSULATED FLAG TERMINALS  
FROM 1.5 TO 2.5 SQ.MM.  
AWG 22-18, 16-14.  
LENGTH: 225 MM  
WEIGHT: 0.56 KGS

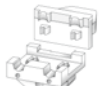

## ■ Model No. TP-690

FOR INSULATED TERMINALS FROM 0.5 TO 6 SQ.  
MM. AWG 22-18, 16-14, 12-10.  
LENGTH: 225 MM  
WEIGHT: 0.56 KGS



## ■ Model No. TP-690L

FOR INSULATED TERMINALS FROM 0.5 TO 6 SQ.  
MM. AWG 22-18, 16-14, 12-10.  
LENGTH: 242 MM  
WEIGHT: 0.57 KGS



## ■ Model No. TP-680

FOR NON-INSULATED TERMINALS 10 AND 16 MM<sup>2</sup>.  
AWG 8 - 6.  
LENGTH: 242 MM  
WEIGHT: 0.54 KGS





## RATCHET CONTROL CRIMPING TOOLS

### ■ Model No. HD-38G

FOR NON INSULATED TERMINAL 8, 14, 22,38 SQ.MM.  
LENGTH: 340MM  
WEIGHT: 0.69 KGS



### ■ Model No. HD-25G

FOR NON INSULATED TERMINAL 5.5, 8, 14, 22 SQ.MM.  
LENGTH: 332MM  
WEIGHT: 0.68 KGS



### ■ Model No. HD-16M

FOR NON INSULATED TERMINAL 1.25, 2.0, 5.5, 8, 14, SQ.MM.  
LENGTH: 245MM  
WEIGHT: 0.39 KGS



### ■ Model No. HD-6S

FOR NON INSULATED TERMINAL 1.25, 2.0 SQ.MM.  
LENGTH: 205MM  
WEIGHT: 0.39 KGS



### ■ Model No. HD-6XS

FOR NON INSULATED TERMINAL 1.25, 2.0, 3.5, 5.5 SQ.MM.  
LENGTH: 176MM  
WEIGHT: 0.25 KGS



### ■ Model No. HD-10"FRAME

10" LONG FRAME, SMOOTH RATCHETING MECHANISM DESIGN AND LESS FORCE TO CRIMP. DIES ARE SOLD SEPARATELY BY REQUEST (NOT LIST IN THIS CATALOGUE)  
NOTE: NOT SUITABLE FOR 9" & 8" DIES  
LENGTH: 260 MM  
WEIGHT: 0.58 KGS



NOTE: NOT SUITABLE FOR 9" & 8" DIES

## PROFESSIONAL MODULAR TOOLS

### ■ Model No. ASA-486

FOR CRIMPING HANDSET 4P4C, 4P2C PLUGS, 6P6C(RJ-12), 6P4C (RJ-11)... PLUGS AND 8P8C (RJ-45)...PLUGS WORK ALL IN ONE. WITH STRIPPING AND CUTTING FOR 4, 6 AND 8 CONDUCTORS WIRE.  
LENGTH: 228 MM  
WEIGHT: 0.36 KGS



### ■ Model No. ASR-486

SAME AS ASA-486, AND ADDING RATCHETING FUNCTION.  
LENGTH: 228 MM  
WEIGHT: 0.41 KGS



## DELUXE MODULAR TOOLS

### ■ Model No. RJ-46

FOR 4 & 6 POSITIONS TELEPHONE MODULAR PLUGS. CRIMPING STRIPPING & CUTTING IN ONE.  
LENGTH: 220 MM  
WEIGHT: 0.32 KGS



### ■ Model No. RJ-86

FOR 8 & 6 POSITIONS TELEPHONE MODULAR PLUGS. CRIMPING STRIPPING & CUTTING IN ONE.  
LENGTH: 220 MM  
WEIGHT: 0.32 KGS



## ■ Model No. RJ-46D

FOR 4 POSITIONS TELEPHONE MODULAR PLUGS.  
& 6 DEC PLUGS.  
CRIMPING STRIPPING & CUTTING IN ONE.  
LENGTH: 220 MM  
WEIGHT: 0.32 KGS



## ■ Model No. RJ-86D

FOR 8 POSITIONS TELEPHONE MODULAR PLUGS.  
& 6 DEC PLUGS.  
CRIMPING STRIPPING & CUTTING IN ONE.  
LENGTH: 220 MM  
WEIGHT: 0.32 KGS



## ■ Model No. RJ-45

SIMPLIFY CRIMP TOOL FOR RJ-45(8 POSITIONS)  
STRIPPING & CUTTING FLAT CABLE & ROUND CABLE.  
CRIMPING STRIPPING & CUTTING IN ONE.  
LENGTH: 200 MM  
WEIGHT: 0.24 KGS



## ■ Model No. RJ-46B

RATCHET CRIMP TOOL FOR RJ-22(4 POSITIONS) AND  
RJ-11(6 POSITIONS) MODULAR PLUGS.  
CRIMPING STRIPPING & CUTTING IN ONE.  
LENGTH: 217 MM  
WEIGHT: 0.47 KGS



## ■ Model No. RJ-68N

RATCHET CRIMP TOOL FOR RJ-11(6 POSITIONS) AND  
RJ-45(8 POSITIONS) MODULAR PLUGS.  
CRIMPING STRIPPING & CUTTING IN ONE.  
LENGTH: 215 MM  
WEIGHT: 0.48 KGS



## ■ Model No. RJ-68P

RATCHET CRIMP TOOL FOR RJ-11(6 POSITIONS) AND  
RJ-45(8 POSITIONS) MODULAR PLUGS.  
STRIPPING & CUTTING FLAT CABLE & ROUND CABLE.  
CRIMPING AREA IS MADE OF PLASTIC  
LENGTH: 218 MM  
WEIGHT: 0.46 KGS



## ■ Model No. RJ-68S

RATCHET CRIMP TOOL FOR RJ-11(6 POSITIONS) AND  
RJ-45(8 POSITIONS) MODULAR PLUGS.  
STRIPPING & CUTTING FLAT CABLE & ROUND CABLE.  
CRIMPING AREA IS MAKING OF LOST WAX MOULDING  
LENGTH: 218 MM  
WEIGHT: 0.51 KGS



## ■ Model No. RJ-468A

RATCHET CRIMP TOOL FOR RJ-22(4 POSITIONS),  
RJ-11(6 POSITIONS) AND RJ-45(8 POSITIONS)  
MODULAR PLUGS.  
CRIMPING STRIPPING & CUTTING IN ONE.  
LENGTH: 225 MM  
WEIGHT: 0.49 KGS



## ■ Model No. RJ-468B

SIMPLIFY CRIMP TOOL FOR RJ-22(4 POSITIONS),  
RJ-11(6 POSITIONS) AND RJ-45(8 POSITIONS)  
MODULAR PLUGS.  
CRIMPING STRIPPING & CUTTING IN ONE.  
LENGTH: 235 MM  
WEIGHT: 0.27 KGS



## ■ Model No. RJ-468C

STRAIGHT MOTION AND PRECISE CRIMPING  
FOR RJ-22(4 POSITIONS), RJ-11(6 POSITIONS)  
AND RJ-45(8 POSITIONS)  
CRIMPING SOLID & STRANDED WIRE.  
CUTS, STRIPS, AND CRIMPS MODULAR PLUS  
WITHOUT CHANGING MODULAR (DIE) SET  
LENGTH: 207 MM  
WEIGHT: 0.44 KGS



# DIE FOR HD-8" FRAME

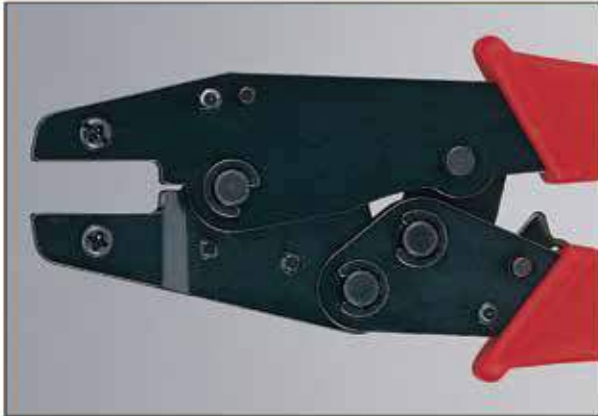

**CE-001**  
FOR CORD END TERMINALS  
FROM 0.5 TO 2.5 SQ. MM.  
AWG 22-14.



**CE-002**  
FOR CORD END TERMINALS  
FROM 0.5 TO 6 SQ. MM.  
AWG 22-10.

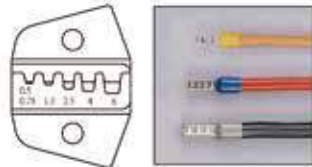

**CE-003**  
FOR CORD END TERMINALS  
FROM 4 TO 16 SQ. MM.  
AWG 12-6.

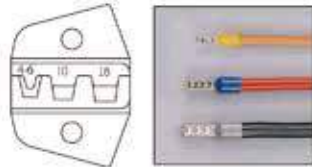

**CE-616**  
FOR CORD END TERMINALS  
FROM 6 TO 16 SQ. MM.  
AWG 10-6.

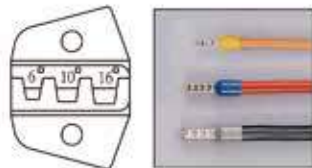

**HD-11010**  
FOR OPEN BARREL  
TERMINALS AWG 24-14.



**HD-11011**  
FOR D-SUBMINIATURE  
CONTACTS RS232 PIN  
AND SOCKETS AWG 30-18.

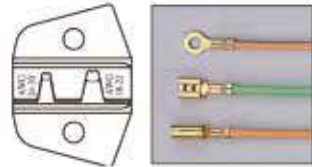

**HD-0325**  
FOR NON-INSULATED  
TERMINALS 0.75 TO 2.5 SQ. MM.  
DIE TERMINAL  
0.75 0.5-0.75 SQ. MM.  
1.5 1.0-1.5 SQ. MM.  
2.5 2.5 SQ. MM.

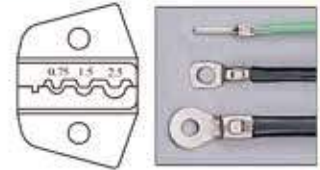

**HD-0110**  
FOR INSULATED TERMINALS  
0.14 TO 10. SQ. MM.  
DIE DOT TERMINAL  
YELLOW 0.14-0.25 SQ. MM.  
GREEN 0.25-0.5 SQ. MM.  
RED(-1) 0.5-1.0 SQ. MM.

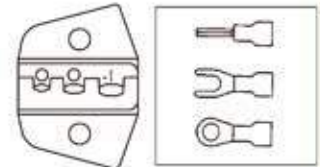

**HD-0725**  
FOR INSULATED  
TERMINALS 0.5 TO 2.5  
SQ. MM.  
AWG 22-18, 16-14

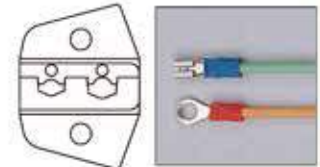

**RG-801**  
FOR COAX CONNECTORS  
RG-58, RG-59, RG-62  
3PC BNC & TNC

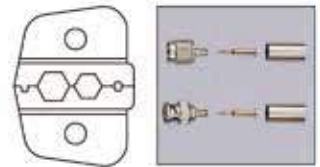

**RG-802**  
FOR COAX CONNECTORS  
RG-58, RG-59, TFE  
2PC BNC & TNC

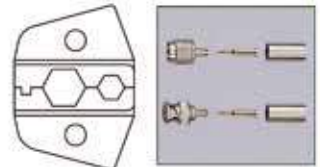

**RG-803**  
FOR COAX CONNECTORS  
RG-58, RG-62  
2PC BNC & TNC

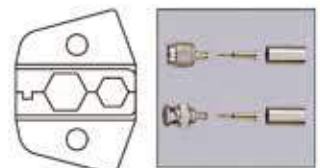

**RG-804**  
FOR COAX CONNECTORS  
RG-55, RG-58, RG-59,  
TFE 62, 141, 142, 223, 303, 400  
3PC BNC & TNC Mini-UHF

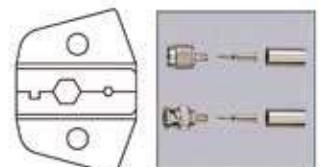

**RG-805**  
FOR COAX CONNECTORS  
RG-59, 62, 8X, 140, 210, 450  
3PC BNC & TNC Mini-UHF

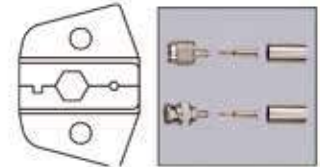

# DIE FOR HD-8" FRAME



**RG-806**  
FOR COAX CONNECTORS  
RG-122, 174, 179, 180, 187,  
188, 195, 316, 3218, 34M  
3PC BNC & TNC Mini-UHF.

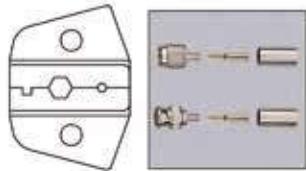

**RG-807**  
FOR FIBER OPTICAL  
CONNECTORS

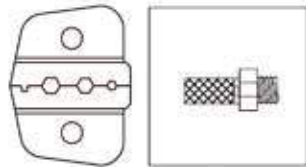

**RG-808**  
FOR COAX CONNECTORS  
N-CONNECTORS

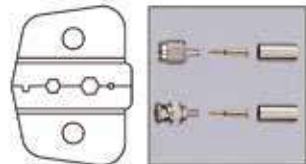

**RG-809**  
FOR COAX CONNECTORS  
N-CONNECTORS

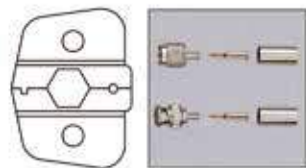

**RG-810**  
FOR COAX CONNECTORS  
N-CONNECTORS

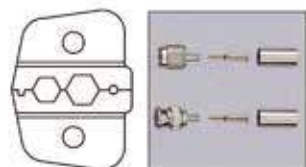

**RG-811**  
FOR COAX CONNECTORS  
N-CONNECTORS

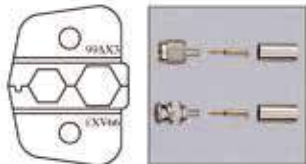

**RG-812**  
FOR COAX CONNECTORS  
N-CONNECTORS

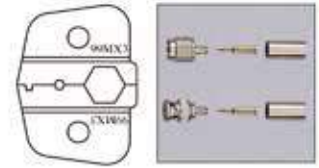

**RG-813**  
FOR COAX CONNECTORS  
N-CONNECTORS

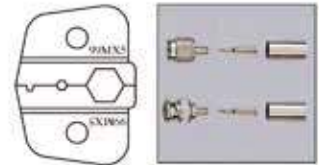

**RG-8401**  
AT & T/ST OR SMA FIBER-  
OPTIC CONN.  
0.190 (4.83MM) HEX,  
0.090 (2.29MM) ROUND,  
0.105 (2.67MM) ROUND

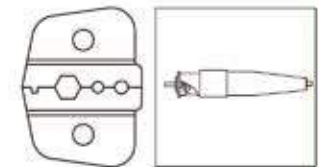

**RG-8402**  
AMPHENOL SMA FIBER-  
OPTIC CONN.  
HEX 0.213 (5.54MM)  
0.178 (4.52MM)

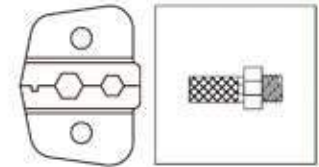

**RG-8403**  
AMPHENOL SMA FIBER-  
OPTIC CONN.  
HEX 0.218 (5.54MM)  
0.151(3.84MM)

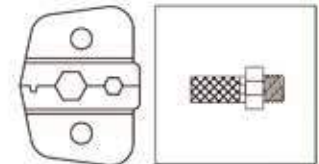

**RG-8404**  
3M/ST FIBER-OPTIC CONN.  
HEX 0.153 (3.88MM)

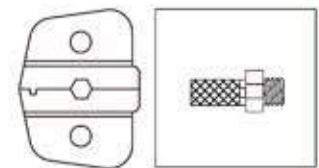

**RG-8405**  
FIBER-OPTIC CONN.  
HEX 0.151 (3.84MM)  
0.178 (4.52MM)  
0.213 (5.41MM)

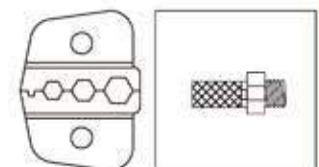

**RG-8406**  
OFTI FIBER-OPTIC CONN.  
HEX 0.128 (3.25MM)  
0.151 (3.84MM)

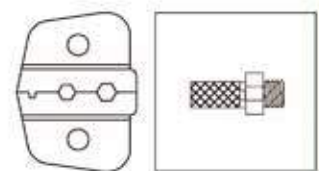

# DIE FOR RG-9" FRAME



**RG-9317**  
FOR COAX CONNECTORS  
RG-58, 59, 62 AU  
BNC & TNC

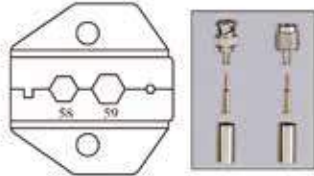

**RG-9318**  
FOR COAX CONNECTORS  
RG-58, 59, 62 AU PC-88 &  
CP-89 SERIES CAMBRIDGE  
CONNECTORS

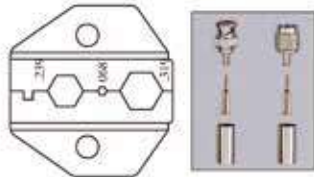

**RG-9319**  
FOR COAX CONNECTORS  
RG-8, 11, RG-213 &  
RG-216 N-SERIES BNC  
COAX CONNECTORS

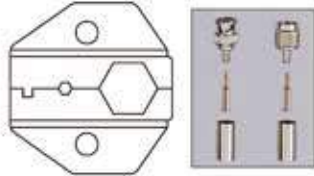

**RG-9328**  
FOR COAX CONNECTORS  
RG-59/6, 6Q  
F-TYPE (CATV)

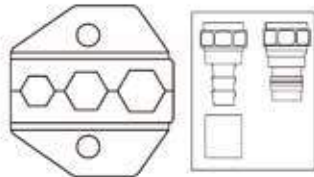

**RG-9330**  
FOR FIBER OPTICAL CONNECTORS

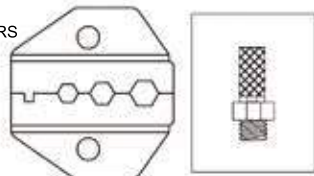

**RG-9030**  
FOR FIBER OPTICAL CONNECTORS

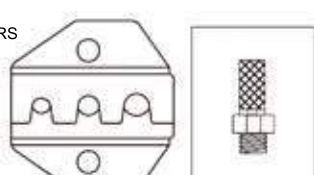

**RG-9046**  
FOR COAX CONNECTORS  
RG-58/174

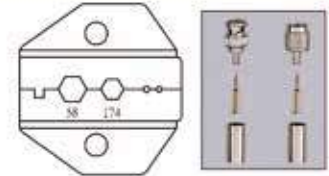

**RG-9047**  
FOR COAX CONNECTORS  
RG-58/8281

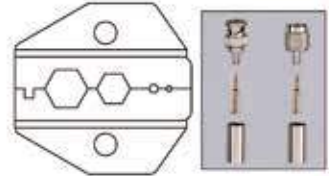

**RG-9050**  
FOR COAX CONNECTORS  
RG-8 N-SERIES

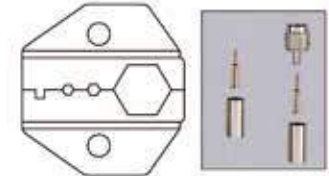

**RG-9051**  
FOR COAX CONNECTORS  
RG-174 Mini 59

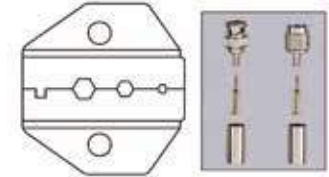

**RG-9601**  
FOR TWINAX COAX CONNECTORS

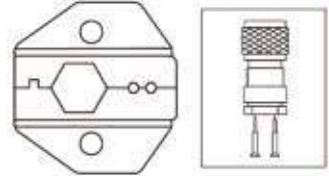

**RG-9602**  
FOR AMP RG-58 DUAL  
CRIMP BNC/TNC COAX  
CONNECTORS "0" .218  
AND .049

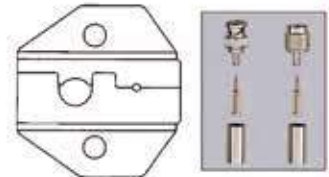

**RG-9603**  
FOR AMP RG-58 DUAL  
CRIMP BNC/TNC COAX  
CONNECTORS "0" .240  
AND .042 BOX CENTER  
PIN

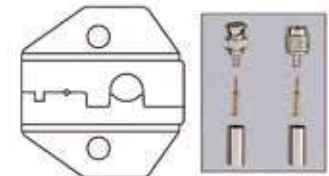

**RG-9600**  
FOR BNC, TNC & Mini-UHF  
CONNECTORS USED ON  
RG-58, 59, 62, 141, 142, 210, 303, 400  
BELDEN 8279, 8281, 9231, 9141  
RG-6, 212, 222, 304



# DIE FOR RG-9" FRAME

**HD-A228**  
FOR NON-INSULATED  
TERMINALS AWG 22-8

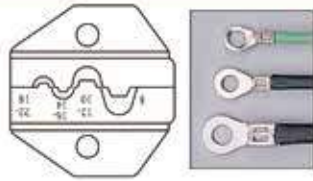

**HD-NF 1**  
FOR NON-INSULATED  
FLAG TERMINALS FROM  
0.5 TO 2.5 SQ. MM.  
AWG 22-18, 16-14

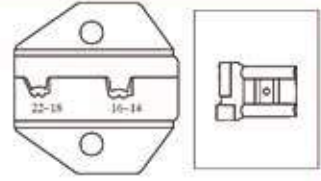

**HD-6PD**  
FOR 6 DEC. PLUG. WITH STRIPPING  
AND CUTTING  
FOR 6 CONDUCTORS WIRE.

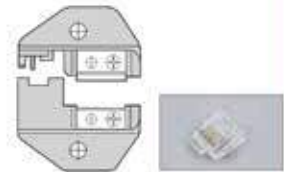

**HD-RJ45 AMP**  
FOR RJ45 AMP PLUG. WITH  
STRIPPING AND CUTTING FOR  
8 CONDUCTORS WIRE.



**HD-RJ11N**  
FOR RJ11, 2, 4 OR 6 POSITION MODULAR  
PLUG.  
WITH STRIPPING AND CUTTING FOR 2, 4, 6  
CONDUCTORS WIRE.

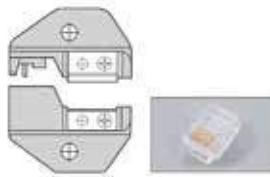

**HD-10P**  
CRIMPING TOOL FOR 10 POSITION  
MODULAR PLUG.  
WITH STRIPPING AND  
CUTTING FOR 10 CONDUCTORS WIRE.



**HD-RJ45N**  
RJ45, 8 POSITION KEYED OR NON-KEYED  
MODULAR PLUG. WITH STRIPPING  
AND CUTTING FOR 8 CONDUCTORS WIRE.



**HD-BT6P**  
FOR BRITISH PLUG WITH STRIPPING  
AND CUTTING FOR 6 CONDUCTORS  
WIRE



# DIE FOR HD-9" FRAME



**CE-1635**  
FOR CORD END TERMINALS FROM 16 TO 35 SQ.MM. AWG 6-2.



**CE-510**  
FOR CORD END TERMINALS FROM 0.5 TO 10 SQ.MM. AWG 22-8.



**HD-0560**  
FOR INSULATED TERMINALS FROM 0.5 TO 6 SQ.MM. AWG 22-18, 16-14, 12-10.

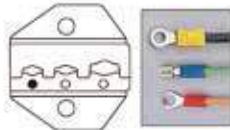

**HD-F0560**  
FOR NON-INSULATED OPEN BARREL TERMINALS FROM 1.5 TO 6 SQ.MM. AWG 22-18, 16-14, 12-10.

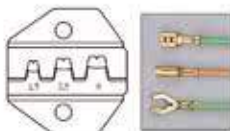

**LKT-F0560**  
LOCATER FOR HD-F0560



**HD-156**  
FOR NON-INSULATED TERMINALS AND CABLE LUGS FROM 1.5 TO 6 SQ.MM. AWG 22-18, 16-14, 12-10.

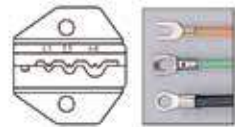

**HD-0510**  
FOR NON-INSULATED TERMINALS DIN 46234 FROM 0.5 TO 10 SQ. MM. AWG 22-18, 16-14, 12-10 AND 8



**CLD-125**  
FOR CLOSE END CONNECTOR AND WPS-WATER PROOF SPLICE FROM 1.5 TO 6 SQ.MM. AWG 22-18, 16-14, 12-10.

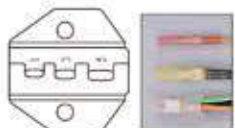

**HD-FLAG**  
FOR INSULATED FLAG TERMINALS FROM 1.5 TO 2.5 SQ.MM. AWG 22-18, 16-14.

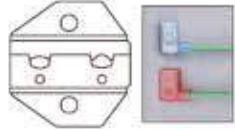

**HD-SWLK**  
FOR STEEL-WIRE LOCK CONNECTOR

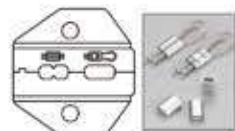

# PUNCH DOWN TOOL

## ■ Model No. HD-601AB

INCLUDING BLADE HD601A AND HD601B

BLADE	TERMINAL BLOCK
HD601A	USE ON 66 TYPE
HD601B	USE ON 110 / 88 TYPE



## ■ Model No. **HD-10120**

FOR CABLE LUGS FROM 10 TO 120 SQ.MM.  
BY A SIMPLE SCREW ADJUSTMENT.  
LENGTH: 570 MM  
WEIGHT: 3.10 KGS



## ■ Model No. **HD-K95**

FOR CABLE LUGS FROM 16 TO 95 SQ.MM. WITH  
MOVEABLE AND REVOLVING DIE.  
ALUMINUM TUBE HANDLE WITH INSULATED  
SHRINK.  
LENGTH: 645 MM  
WEIGHT: 2.90 KGS



## ■ Model No. **HD-120**

FOR CABLE LUGS FROM 16 TO 120 SQ.MM.  
BY A SIMPLE SCREW ADJUSTMENT.  
LENGTH: 645 MM  
WEIGHT: 3.50 KGS



## ■ Model No. **HD-0650**

FOR CABLE LUGS FROM 6 TO 50 SQ.MM.  
HEXAGONAL PRESSURE.  
LENGTH: 390 MM  
WEIGHT: 1.10 KGS



## ■ Model No. **HD-1695**

FOR CABLE LUGS FROM 16 TO 95  
SQ.MM. HEXAGONAL PRESSURE.  
LENGTH: 520 MM  
WEIGHT: 2.50 KGS



## ■ Model No. **HD-06120**

FOR CABLE LUGS FROM 6 TO 120  
SQ.MM. HEXAGONAL PRESSURE.  
LENGTH: 650 MM  
WEIGHT: 4.00 KGS



## ■ Model No. **HD-25150**

FOR CABLE LUGS FROM 25 TO 150  
SQ.MM. HEXAGONAL PRESSURE.  
LENGTH: 650 MM  
WEIGHT: 4.00 KGS





## ■ Model No. **HD-BGD3 / HD-OD3**

Length: 652 mm

Weight: 3.20 kgs

Packaging: Box

## ■ Crimping Capacity:

- Crimping Force: 4.5 ton
- Uses W-style dies.
- Storage carrying case & dies are sold separately.

## ■ Features:

- Proper crimps are assured with butting steel jaws.
- Increased strength and greater bearing area is provided with larger steel bolts.
- Fast, easy, one-hand die insertion.
- No lost dies with spring loaded positive lock die retainer buttons.
- Full crimp force assured with over center cam action.
- Operator protection provided with butt stops and heat shrink tubing.
- Long life expectancy provided with fiberglass handles and light weight high strength aluminum alloy castings.
- The "D3" groove accommodates the line of type "W"-die inserts.



## ■ Model No. **CASE-OD3**

## ■ Connector Range:

- Copper, Aluminum, ACSR, Copperweld, Alumoweld, Steel, 6201, 5005, Compressed and Compact conductors.
- Copper Taps: # 10 sol.-2/0 str.
- Aluminum, ACSR Taps: # 14 sol. -4/0 ACSR
- Stirrups: # 6 ACSR-4/0 ACSR
- Overhead Full Tension Deadend, Full Tension Splices, Non Tension Splices, and Terminals Conductor Range: # 10 str. -4/0 ACSR
- Code conductor connectors: # 6-4/0 str. Copper and Aluminum

KuDos KW-dies	KW-BG	KW-O	KW-C	KW-K840	KW-161	KW-162	KW-163	KW-164
Burndy W-Dies	W-BG	W-O	W-C	W-K840	W-161	W-162	W-163	W-164

KuDos KW-dies	KW-165	KW-166	KW-171	KW-237	KW-243	KW-247	KW-249	KW-702
Burndy W-Dies	W-165	W-166	W-171	W-237	W-243	W-247	W-249	W-702



## ■ Close View of NEW LEC series Features



●LED light support



●Widen shoulder strape with soft pad which gives the tool easy operate



●Ergonomic design and comfortable to use with anti-slip coated grip



●Power indicator  
● Active / standby  
☀ Power is on  
☀ Power is low  
☀ Overcurrent protection



●Bosch battery power indicator 14.4V Li-ion battery

■ **Model No. LEC-25** (with Li-ion Battery & Charger)

Height : 335 mm  
Weight : 5.2 kgs (battery included)

■ **Specifications:**

Drive unit : 14.4V DC Motor  
Charger (GS/CE) :  
Input voltage : 110V Single Phase AC  
Input voltage : 230V Single Phase AC  
Input frequency : 50-60 Hz  
Input current : 21.75 VA  
Reservoir capacity : 120 cc

■ **Crimping Capacity:**

Max. Pressure : 450 bar  
Max Output : 4.8 tons / 47 kN  
Crimping Die Sets As Below  
(Sold Separately )



※ 3 CRIMPING JAWS ARE SOLD SEPARATELY.

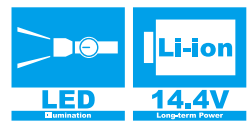

## ■ Model No. **LEC-25 Die Set**

Weight : 3.0 kgs

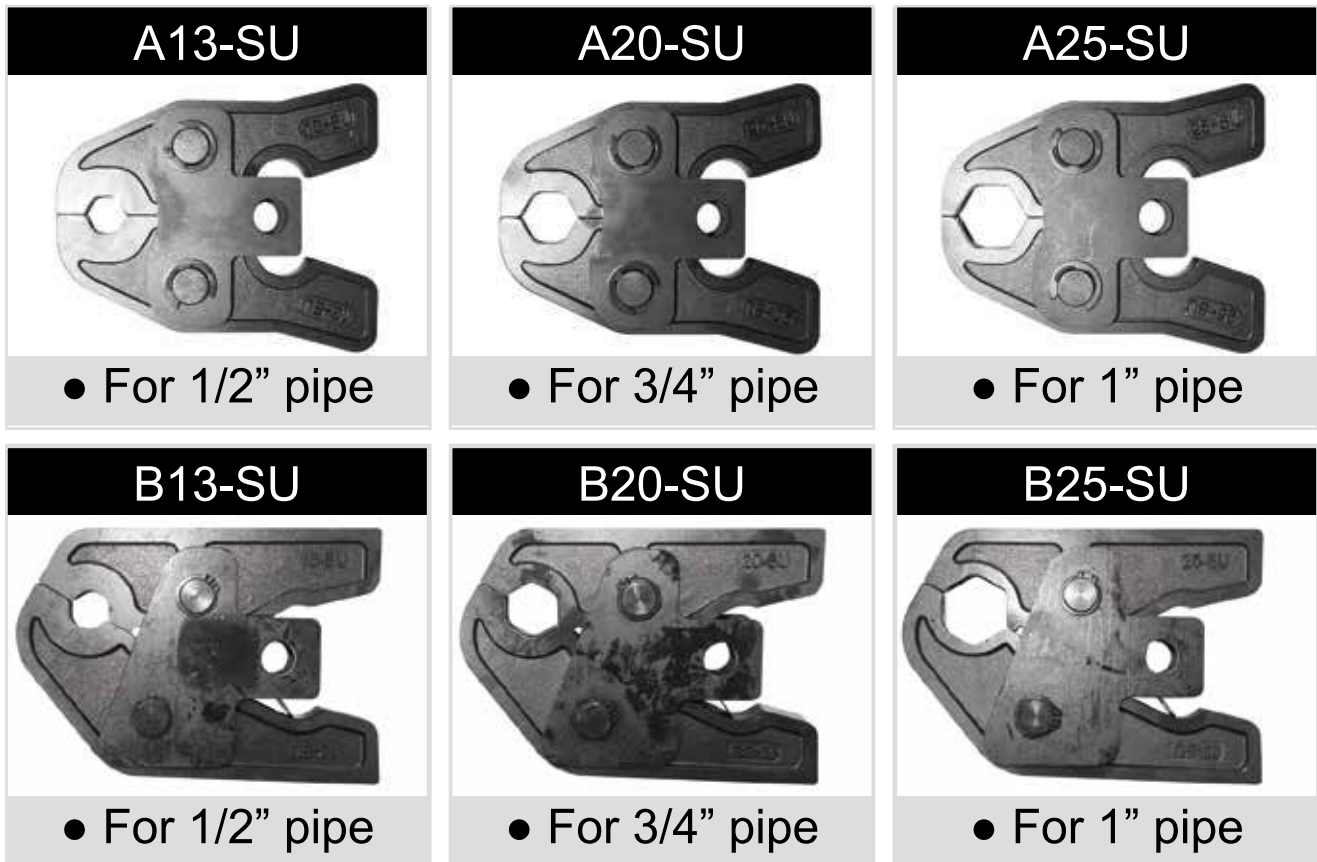

※(Standard JIS G3448)

## ■ Exchange The Die Set Operate Procedure



## ■ Model No. **LEC-185T** (with Li-ion Battery & Charger)

Length : 310 mm

Weight : 4.6 kgs (battery included)

### ■ Specifications:

Drive unit : 14.4V DC Motor  
 Charger (GS/CE):  
 Input voltage : 110V Single Phase AC  
 Input voltage : 230V Single Phase AC  
 Input frequency : 50-60 Hz  
 Input current : 21.75 VA  
 Reservoir capacity : 145 cc

### ■ Crimping Capacity:

Max Pressure : 460 bar  
 Max. Output : 5.3 tons / 52 kN  
 Max. Compression : 185 mm<sup>2</sup> copper  
 Accepts BEKU type dies  
 Stock Dies are for DIN 46235 Terminals  
 Dies sold separately (See page 151)  
 (AHE 1016 / 2535 / 5070 / 95120 / 150 / 185)

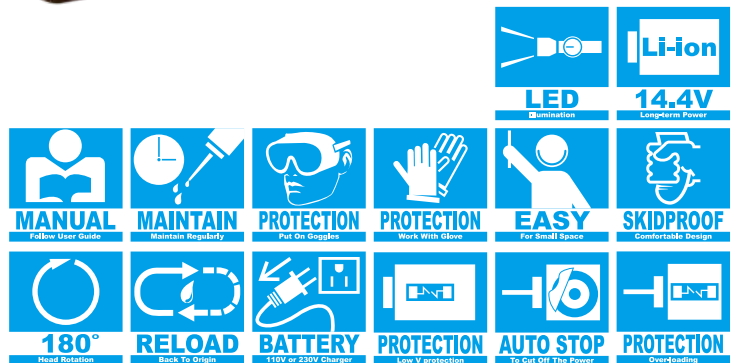

# BATTERY OPERATED TOOLS

## ■ Model No. **LEC-240T** (with Li-ion Battery & Charger)

Height : 360 mm

Weight : 4.9 kgs (battery included)

### ■ Specifications:

Drive unit : 14.4V DC Motor  
 Charger (GS/CE):  
 Input voltage : 110V Single Phase AC  
 Input voltage : 230V Single Phase AC  
 Input frequency : 50-60 Hz  
 Input current : 21.75 VA  
 Reservoir capacity : 145 cc

### ■ Crimping Capacity:

Max Pressure : 550 bar  
 Max. Output : 5.3 tons / 52 kN  
 Max. Compression : 240 mm<sup>2</sup> copper  
 Accepts BEKU type dies  
 Stock Dies are for DIN46235 Terminals  
 Dies sold separately (See page 151)  
 (AHE 1016 / 2535 / 5070 / 95120 / 150 / 185 / 240)

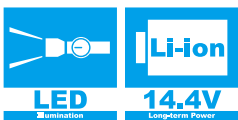

■ **Model No. LEC-U26** (with Li-ion Battery & Charger)

Height : 378 mm  
Weight : 5.0 kgs (battery included)



■ **Specifications:**

Drive unit : 14.4V DC Motor  
Charger (GS/CE) :  
Input voltage : 110V Single Phase AC  
Input voltage : 230V Single Phase AC  
Input frequency : 50-60 Hz  
Input current : 21.75 VA  
Reservoir capacity : 120 cc

■ **Crimping Capacity:**

U-Type Head  
Crimping force : 12.7 tons / 125 kN  
**Main Applications :**  
Cu conductors : 400 mm<sup>2</sup>  
Al conductors : 240 mm<sup>2</sup>  
C sleeves connector : 120 mm<sup>2</sup>



<b>HEXAGONAL</b>	<b>INDENT TYPE</b>	<b>TERMINAL</b>	<b>C-CONNECT</b>	<b>SPEED DELIVERY</b>	<b>MANUAL</b> Follow User Guide	<b>MAINTAIN</b> Maintain Regularly	<b>PROTECTION</b> Put On Goggles	<b>PROTECTION</b> Work With Glove	<b>EASY</b> For Small Space	<b>SKIDPROOF</b> Comfortable Design	<b>LED</b> Illumination	<b>Li-ion</b> <b>14.4V</b> Long-term Power
<b>330°</b> Head Rotation	<b>RELOAD</b> Back To Origin	<b>BATTERY</b> 110V or 230V Charger	<b>PROTECTION</b> Low V protection	<b>AUTO STOP</b> To Cut Off The Power	<b>PROTECTION</b> Overloading							

## ■ Model No. **LEC-U27** (with Li-ion Battery & Charger)

Height : 323 mm

Weight : 7.0 kgs (battery included)

### ■ Specifications:

Drive unit : 14.4V DC Motor

Charger (GS/CE):

Input voltage : 110V Single Phase AC

Input voltage : 230V Single Phase AC

Input frequency : 50-60 Hz

Input current : 21.75 VA

Reservoir capacity : 120 cc

### ■ Crimping Capacity:

U-Type Head

Crimping force : 12.7 tons / 125 kN

#### Main Applications :

L.V lugs & splices : 400 mm<sup>2</sup>

Insulated Terminals : 240 mm<sup>2</sup>

C sleeve connector : 185 mm<sup>2</sup>

H.V.lugs & splices : 400 mm<sup>2</sup>

Al lugs & splices : 300 mm<sup>2</sup>

Dies sold separately (See page 151)

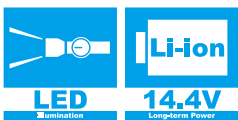



■ **Model No. LEC- 150** (with Li-ion Battery & Charger)

Length : 354 mm

Weight : 5.4 kgs (battery included)

■ **Specifications:**

- Drive unit : 14.4V DC Motor
- Charger (GS/CE):
- Input voltage : 110V Single Phase AC
- Input voltage : 230V Single Phase AC
- Input frequency : 50-60 Hz
- Input current : 21.75 VA
- Reservoir capacity : 152 cc

■ **Crimping Capacity:**

- Max. Pressure : 700 bar
- Oil Required : 31 cc
- Crimping force : 12.7 tons / 125 kN
- Main Application : Up to 150mm<sup>2</sup> CU

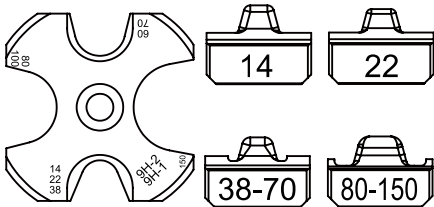

# BATTERY OPERATED TOOLS

## ■ Model No. **LEC-32** (with Li-ion Battery & Charger)

Height : 328 mm

Weight : 7.0 kgs (battery included)

### ■ Specifications:

Drive unit : 14.4V DC Motor

Charger (GS/CE):

Input voltage : 110V Single Phase AC

Input voltage : 230V Single Phase AC

Input frequency : 50-60 Hz

Input current : 21.75 VA

Reservoir capacity : 120 cc

### ■ Crimping Capacity:

Jaw opening : 32mm

Crimping force : 12.7 tons / 125 kN

Main Application : Up to 400mm<sup>2</sup> CU

Dies sold separately (See page 151)



- Insulated cap should be ordered separately.

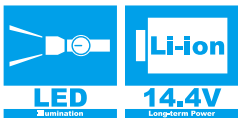

Accepts all dies used by Alcoa, Burndy, T&B, Klauke, Cembre and Blackburn 12 ton U-type dies. Suitable for TERMINALS with wall thickness little less than DIN 46235 cable lugs.





■ **Model No. LEC-40** (with Li-ion Battery & Charger)

Height : 387 mm  
Weight : 6.8 kgs (battery included)

■ **Specifications:**

Drive unit : 14.4V DC Motor  
Charger (GS/CE) :  
Input voltage : 110V Single Phase AC  
Input voltage : 230V Single Phase AC  
Input frequency : 50-60 Hz  
Input current : 21.75 VA  
Reservoir capacity : 120 cc

■ **Crimping Capacity:**

Jaw opening : 40 mm  
Crimping force : 12.7 tons / 125 kN  
Main Application : Up to 400mm<sup>2</sup> CU  
Dies sold separately (See page 151)



Accepts all dies used by Alcoa, Burndy, T&B, Klauke, Cembre and Blackburn 12 ton U-type dies. Suitable for TERMINALS with wall thickness little less than DIN 46235 cable lugs.

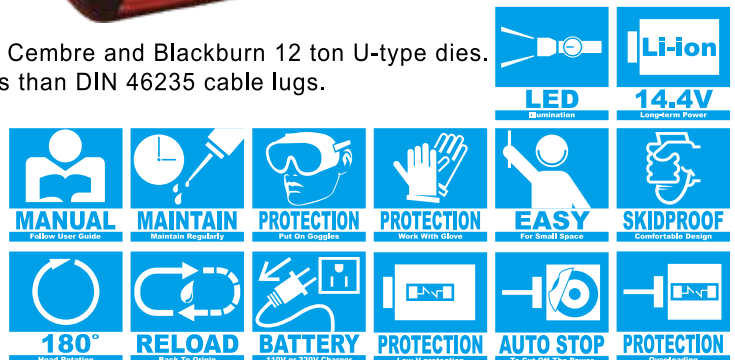

# BATTERY OPERATED TOOLS

## ■ Model No. **LEC-44** (with Li-ion Battery & Charger)

Height : 363 mm

Weight : 7.8 kg (battery included)

### ■ Specifications:

Drive unit : 14.4V DC Motor

Charger (GS/CE):

Input voltage : 110V Single Phase AC

Input voltage : 230V Single Phase AC

Input frequency : 50-60 Hz

Input current : 21.75 VA

Reservoir capacity : 205 cc

### ■ Crimping Capacity:

Jaw opening : 44mm

Crimping force : 12.7 tons / 125 kN

Main Application : Up to 400mm<sup>2</sup> CU

Dies sold separately (See page 151)



- Insulated cap should be ordered separately.

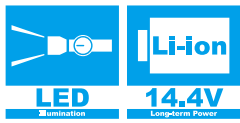

Accepts all dies used by Alcoa, Burndy, T&B, Klauke, Cembre and Blackburn 12 ton U-type dies. Suitable for TERMINALS with wall thickness little less than DIN 46235 cable lugs.

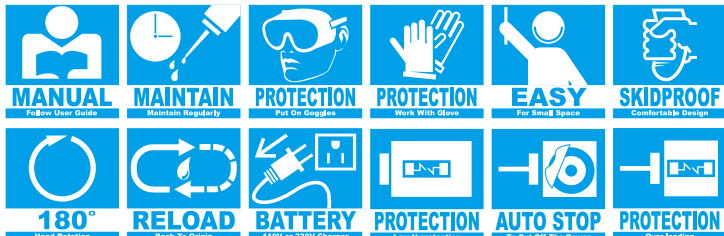



■ **Model No. LEC-45X** (with Li-ion Battery & Charger)  
Weight : 5.0 kgs (With Battery, w/o any head)

■ **Specifications:**

- Drive unit : 14.4V DC Motor
- Charger (GS/CE) :
- Input voltage : 110V Single Phase AC
- Input voltage : 230V Single Phase AC
- Input frequency : 50-60 Hz
- Input current : 21.75 VA
- Reservoir capacity : 120 cc

■ **Crimping Capacity:**

- LEC-45X can be transformed with 6 different adapter heads as Cable Cutter \ Puncher \ Crimper \ Bus Bar Cutter \ Nut Splitter \ Puncher.
- Max Output : 12.7 tons / 125 kN
- Ram Stroke : 44 mm



※ 6 ADAPTER HEADS ARE SOLD SEPARATELY.

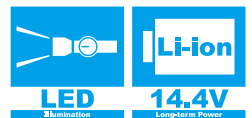

## ■ Model No. **LEC-44X / LEC-45X (Related heads)**

### **44AT-Hex** (Hex. Crimping Head Adapter)

Main Application : 10-400 mm<sup>2</sup>  
Die sold separately : 16, 25, 35, 50, 70, 95, 120,  
150, 185, 240, 300, 400 mm<sup>2</sup>  
Accept all 12 tons die sets



### **44AT-50AP** (Panel Punching Head Adapter)

Punching Capacity :  
Mild Steel Panel thickness : 7mm / Dia : 17.5mm  
Copper Panel thickness : 7mm / Dia : 20.5mm  
Included Round Punching Die Sets :  
10.5, 13.5, 17.5, 20.5 mm each set for mild steel.  
\*\*Die sets for copper panel sold separately.



### **44AT-NC36** (Nut Splitter Head Adapter)

Bolt Range : M10~M24  
Hex. Nut Range : 16~36mm



### **44AT-50AC** (Angle Steel Cutter Head Adapter)

Max. Width : 50mm  
Max. Thickness : 6mm



### **44AT-SC40** (Cable Cutter Head Adapter)

Cutting Capacity  
ACSR : 40mm  
Copper : 44mm



### **44AP-MM36** (Nut Splitting Head)

Bolt Range : M10~M26  
Hex. Nut Range : 36mm



■ **Model No. LEC-240** (with Li-ion Battery & Charger)

Height : 327 mm

Weight : 5.4 kgs (battery included)

■ **Specifications:**

- Drive unit : 14.4V DC Motor
- Charger (GS/CE):
- Input voltage : 110V Single Phase AC
- Input voltage : 230V Single Phase AC
- Input frequency : 50-60 Hz
- Input current : 21.75 VA
- Reservoir capacity : 145 cc

■ **Crimping Capacity:**

- Max. Pressure : 550 bar
- Max. Compression : 240 mm<sup>2</sup> copper
- Crimping force : 6.2 tons / 61 kN
- Dies sold separately (See page 152)
- (T16/25/35/50/70/95/120/150/185/240)



# BATTERY OPERATED TOOLS



## ■ Model No. **LEC-U240** (with Li-ion Battery & Charger)

Height : 380 mm  
Weight : 4.7 kgs (battery included)

### ■ Specifications:

Drive unit : 14.4V DC Motor  
Charger (GS/CE) :  
Input voltage : 110V Single Phase AC  
Input voltage : 230V Single Phase AC  
Input frequency : 50-60 Hz  
Input current : 21.75 VA  
Reservoir capacity : 120 cc

### ■ Crimping Capacity:

Max. Pressure : 700 bar  
Max. Output : 8.8 tons / 86 kN  
Ram Stroke : 14.5 mm

- Accepts BEKU type dies
- Hex. Crimping : 10-240 mm<sup>2</sup>
- Cu sleeves & lugs NFC 20. 130 : 10 to 240 mm<sup>2</sup>
- Cu or Al bare or insulated sleeve : E54 to E230
- Cu or Al sleeves & lugs DIN 48083 : KZ6 to KZ25
- Pre-rounding : 35 to 240 mm<sup>2</sup>
- Dies sold separately (See page 155)

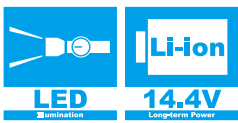

Accepts all dies used by Alcoa, Burndy, T&B, Klauke, Cembre and Blackburn 12 ton U-type dies. Suitable for TERMINALS with wall thickness little less than DIN 46235 cable lugs.





■ **Model No. LEC-6FT** (with Li-ion Battery & Charger)

Height : 400 mm

Weight : 6.4 kgs (battery included)

■ **Specifications:**

Drive unit : 14.4V DC Motor

Charger (GS/CE):

Input voltage : 110V Single Phase AC

Input voltage : 230V Single Phase AC

Input frequency : 50-60 Hz

Input current : 21.75 VA

Reservoir capacity : 120 cc

■ **Crimping Capacity:**

Max. Pressure : 700 bar

Jaw Opening : 38 mm

Oil Required : 29 cc

Crimping force : 6.4 tons / 62 kN

Main Application :

Anderson type connectors up to 750 MCM

■ **Features:**

- 360° rotating head for convenient operation.
- Dieless compression to crimp Anderson style connectors up to 750 MCM.



# BATTERY OPERATED TOOLS

## ■ Model No. **LEC-6** (with Li-ion Battery & Charger)

Height : 386 mm

Weight : 6.2 kgs (battery included)

### ■ Specifications:

Drive unit : 14.4V DC Motor

Charger (GS/CE):

Input voltage : 110V Single Phase AC

Input voltage : 230V Single Phase AC

Input frequency : 50-60 Hz

Input current : 21.75 VA

Reservoir capacity : 120 cc

### ■ Crimping Capacity:

Max. Pressure : 700 bar

Jaw Opening : 35.8 mm

Oil Required : 26.6 cc

Crimping force : 6.4 tons / 62 kN

Main Application:

Anderson type connectors up to 500 MCM

### ■ Features:

- 360° rotating head for convenient operation.
- Dieless compression to crimp Anderson style connectors up to 500 MCM.



- Insulated cap should be ordered separately.

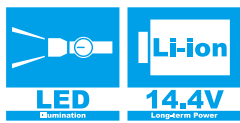

■ **Model No. LEC-S24** (with Li-ion Battery & Charger)

Length : 328 mm

Weight : 6.0 kgs (battery included)

■ **Specifications:**

- Drive unit : 14.4V DC Motor
- Charger (GS/CE):
- Input voltage : 110V Single Phase AC
- Input voltage : 230V Single Phase AC
- Input frequency : 50-60 Hz
- Input current : 21.75 VA
- Reservoir capacity : 145 cc

■ **Cutting Capacity:**

- Max. Pressure : 700 bar
- Oil Required : 32 cc
- Max. Output : 8 tons / 78.4 kN
- Wire rope 6x7 : 18 mm
- Wire rope 6x12 : 24 mm
- Wire rope 6x19 : 24 mm
- Soft steel bar : 20 mm
- Reinforcing rod : 16 mm
- Cu Strands : 24 mm
- Al Strands : 24 mm
- ACSR : 24 mm
- Guy wire 1x7 : 20 mm
- Guy wire 1x19 : 20 mm

**Cutting of piano wire is prohibited.**

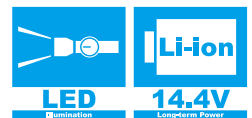

# BATTERY OPERATED TOOLS

## ■ Model No. **LEC-S45** (with Li-ion Battery & Charger)

Height : 328 mm

Weight : 7.1 kgs (battery included)

### ■ Specifications:

Drive unit : 14.4V DC Motor

Charger (GS/CE):

Input voltage : 110V Single Phase AC

Input voltage : 230V Single Phase AC

Input frequency : 50-60 Hz

Input current : 21.75 VA

Reservoir capacity : 120 cc

### ■ Cutting Capacity:

Max. Pressure : 700 bar

Oil Required : 71 cc

Max. Output : 9.7 tons / 96 kN

Wire rope 6x7 : 40 mm

Wire rope 6x12 : 40 mm

Wire rope 6x19 : 40 mm

Soft copper bar : 32 mm

Soft aluminum bar : 40 mm

Soft steel bar : 20 mm

Cu strands : 40 mm

Al strands : 40 mm

ACSR : 40 mm

**Cutting of piano wire is prohibited.**

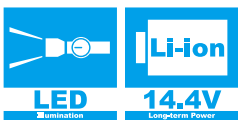

■ **Model No. LEC-S55** (with Li-ion Battery & Charger)

Length : 479 mm

Weight : 9.2 kgs (battery included)

■ **Specifications:**

- Drive unit : 14.4V DC Motor
- Charger (GS/CE):
- Input voltage : 110V Single Phase AC
- Input voltage : 230V Single Phase AC
- Input frequency : 50-60 Hz
- Input current : 21.75 VA
- Reservoir capacity : 120 cc

■ **Cutting Capacity:**

- Max. Pressure : 700 bar
- Oil Required : 106.6 cc
- Max. Output : 12.7 tons / 125 kN
- Wire rope 6x7 : 25 mm
- Wire rope 6x12 : 30 mm
- Wire rope 6x19 : 30 mm
- Soft copper bar : 35 mm
- Soft aluminium bar : 28 mm
- Soft steel bar : 22 mm
- Reinforcing rod : 19 mm
- Cu strands : 54 mm
- Al strands : 54 mm
- ACSR : 54 mm
- Guy wire 1x7 : 15 mm
- Guy wire 1x19 : 20 mm
- Underground cable : 50 mm

**Cutting of piano wire is prohibited.**

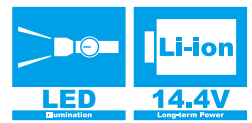

# BATTERY OPERATED TOOLS

## ■ Model No. **LEC-C85** (with Li-ion Battery & Charger)

Height : 345 mm

Weight : 8.0 kgs (battery included)

### ■ Specifications:

Drive unit : 14.4V DC Motor

Charger (GS/CE):

Input voltage : 110V Single Phase AC

Input voltage : 230V Single Phase AC

Input frequency : 50-60 Hz

Input current : 21.75 VA

Reservoir capacity : 120 cc

### ■ Cutting Capacity:

Max. Pressure : 700 bar

Oil Required : 75 cc

Max. Output : 5.6 tons / 56 kN

Material : Copper and  
aluminum cables

Maximum size :  $\varnothing$  85 mm

**Cutting of piano wire is prohibited.**

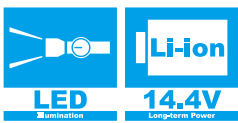

■ **Model No. LEC-30A** (with Li-ion Battery & Charger)

Height : 418 mm  
Weight : 5.2 kgs (battery included)

■ **Specifications:**

Drive unit : 14.4V DC Motor  
Charger (GS/CE):  
Input voltage : 110V Single Phase AC  
Input voltage : 230V Single Phase AC  
Input frequency : 50-60 Hz  
Input current : 21.75 VA  
Reservoir capacity : 120 cc

■ **Cutting Capacity:**

Max. Pressure : 700 bar  
Max. Output : 7.9 tons / 77.8 kN  
Oil Required : 23 cc  
Cu Strands : 28 mm  
Al Strands : 28 mm  
ACSR : 19 mm  
Telephone Cable : 30 mm  
CCP Cable : 30 mm  
Underground Cable : 30 mm  
**Cutting of piano wire is prohibited.**



<b>Bare Strands</b>	<b>ACSR Cable</b>	<b>GUY WIRE</b>	<b>Soft Steel Bar</b>	<b>CU / AL</b>	<b>MANUAL</b> Follow User Guide	<b>MAINTAIN</b> Maintain Regularly	<b>PROTECTION</b> Put On Goggles	<b>PROTECTION</b> Work With Glove	<b>EASY</b> For Small Space	<b>SKIDPROOF</b> Comfortable Design	<b>LED</b> Illumination	<b>14.4V</b> Long-term Power
<b>180°</b> Head Rotation	<b>RELOAD</b> Back To Origin	<b>BATTERY</b> 110V or 230V Charger	<b>PROTECTION</b> Low V protection	<b>AUTO STOP</b> To Cut Off The Power	<b>PROTECTION</b> Overloading							

# BATTERY OPERATED TOOLS

## ■ Model No. **LEC-85YC** (with Li-ion Battery & Charger)

Length : 516 mm

Weight : 8.0 kgs ( battery included)

### ■ Specifications:

Drive unit : 14.4V DC Motor  
 Charger (GS/CE):  
 Input voltage : 110V Single Phase AC  
 Input voltage : 230V Single Phase AC  
 Input frequency : 50-60 Hz  
 Input current : 21.75 VA  
 Reservoir capacity : 120 cc

### ■ Cutting Capacity:

Max. Pressure : 700 bar  
 Max. Output : 8 tons / 78.4 kN  
 Cu strands : 60 mm  
 Al strands : 60 mm  
 CCP cable : 85 mm  
 (Note : Tensile strength (daN/mm<sup>2</sup>)  $\cong$  180)

**Cutting of piano wire is prohibited.**





■ **Model No. REC-50** (with Ni-cd Battery & Charger)

Height : 345 mm

Weight : 2.5 kgs

■ **Cutting Capacity:**

- Max. Cable diameter:  
Nonferrous 50 mm

■ **Specifications:**

Drive unit : 12V DC Motor

Charger (GS/CE):

Input voltage : **REC-50-120**

120V Single Phase AC

Input voltage : **REC-50-230**

230V Single Phase AC

Input frequency : 50-60 Hz

Input current : 21.75 VA

■ **Accessories:**

- KuDos plastic carrying case
- 12V Battery , 110V or 230V Charger  
(See page 77)



※ For reference only

Model No.	Specification
	600V-CV325 mm <sup>2</sup> (31 mm OD)
Polyethylene cable	600V-CV150 mm <sup>2</sup> x 3(46 mm OD)
	600V-CV500 mm <sup>2</sup> (38 mm OD)
	6KV-CVT500 mm <sup>2</sup> (45 mm OD)
Multi-core vinyl insulation cable	VVR150 mm <sup>2</sup> (47 mm OD) 3 core
Soft copper cable	IV500 mm <sup>2</sup> (35 mm OD)
Hard copper cable	150 mm <sup>2</sup> (21 mm OD)



## ■ Model No. **LEC-50** (with Li-ion Battery & Charger)

Height : 313 mm

Weight : 2.4 kgs

### ■ Cutting Capacity:

- Max. Cable diameter:  
Nonferrous 50 mm

### ■ Specifications:

Drive unit : 14.4V DC Motor

Charger (BOSCH):

Input voltage: **LEC-50-120**

110V Single Phase AC

Input voltage: **LEC-50-230**

230V Single Phase AC

Input frequency: 50-60 Hz

Input current : 21.75 VA

### ■ Accessories:

- KuDos plastic carrying case
- 14.4V Battery , 110V or 230V Charger  
(See page 77)



※ For reference only

Model No.	Specification
	600V-CV325 mm <sup>2</sup> (31 mm OD)
Polyethylene cable	600V-CV150 mm <sup>2</sup> x 3(46 mm OD)
	600V-CV500 mm <sup>2</sup> (38 mm OD)
	6KV-CVT500 mm <sup>2</sup> (45 mm OD)
Multi-core vinyl insulation cable	VVR150 mm <sup>2</sup> (47 mm OD) 3 core
Soft copper cable	IV500 mm <sup>2</sup> (35 mm OD)
Hard copper cable	150 mm <sup>2</sup> (21 mm OD)



■ **Model No. REC-54** (with Ni-cd Battery & Charger)

Height : 360 mm

Weight : 4.0 kgs

■ **Crimping Capacity:**

- Max. Cable diameter:  
Nonferrous 54 mm & Steel supported  
400-pair telecom cable

■ **Specifications:**

Drive unit : 14.4V DC Motor

Charger (GS/CE):

Input voltage : **REC-54-120**

120V Single Phase AC

Input voltage : **REC-54-230**

230V Single Phase AC

Input frequency : 50-60 Hz

Input current : 21.75 VA

■ **Accessories:**

- KuDos plastic carrying case
- 14.4V Battery, 110V or 230V Charger  
(See page 77)



※ For reference only

Model No.	Specification
Polyethylene cable	600V-CV325 mm <sup>2</sup> (31 mm OD)
Multi-core vinyl insulation cable	VVR150 mm <sup>2</sup> (47 mm OD) 3 core
SB-ACSR	ACSR120 mm <sup>2</sup> (18.6 mm OD) ACSR shall under steel of 2.0mm
Hard aluminum cable	HAL-OC400 mm <sup>2</sup> (31.9mm OD)
Hard copper cable	OE-OC150 mm <sup>2</sup> (21 mm OD)
SS cable	0.4 mm 400 CCP-F-SS(CR) cable

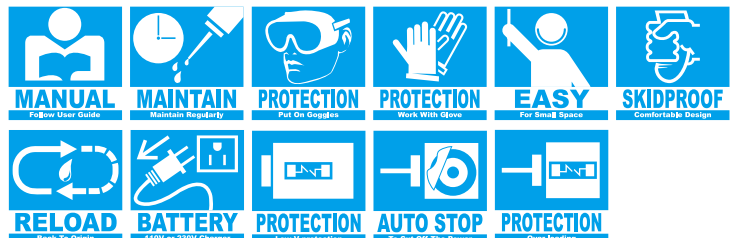
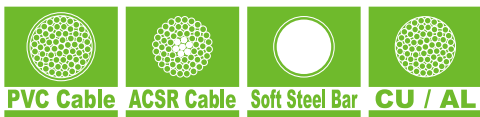

## ■ Model No. **LEC-54** (with Li-ion Battery & Charger)

Height : 326 mm

Weight : 3.0 kgs

### ■ Cutting Capacity:

- Max. Cable diameter:  
Nonferrous 54 mm & Steel supported  
400-pair telecom cable

### ■ Specifications:

Drive unit : 14.4V DC Motor

Charger (BOSCH):

Input voltage: **LEC-54-120**

120V Single Phase AC

Input voltage: **LEC-54-230**

230V Single Phase AC

Input frequency : 50-60 Hz

Input current : 21.75 VA

### ■ Accessories:

- KuDos plastic carrying case
- 14.4V Battery , 110V or 230V Charger  
(See page 77)



※ For reference only

Model No.	Specification
Polyethylene cable	600V-CV325 mm <sup>2</sup> (31 mm OD)
Multi-core vinyl insulation cable	VVR150 mm <sup>2</sup> (47 mm OD) 3 core
SB-ACSR	ACSR120 mm <sup>2</sup> (18.6 mm OD) ACSR shall under steel of 2.0mm
Hard aluminum cable	HAL-OC400 mm <sup>2</sup> (31.9mm OD)
Hard copper cable	OE-OC150 mm <sup>2</sup> (21 mm OD)
SS cable	0.4 mm 400 CCP-F-SS(CR) cable

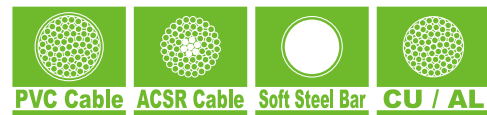

■ **Model No. REC-54AC** (with Ni-cd Battery & Charger)

Height : 360 mm

Weight : 4.0 kgs

■ **Cutting Capacity:**

- Max. Cable diameter:  
Nonferrous 54 mm

■ **Specifications:**

Drive unit : 14.4V DC Motor

Charger (GS/CE):

Input voltage : **REC-54AC-120**

120V Single Phase AC

Input voltage : **REC-54AC-230**

230V Single Phase AC

Input frequency : 50-60 Hz

Input current : 21.75 VA

■ **Accessories:**

- KuDos plastic carrying case
- 14.4V Battery, 110V or 230V Charger  
(See page 77)



※ For reference only

Model No.	Specification
Polyethylene cable	600V-CV325 mm <sup>2</sup> (31 mm OD)
	600V-CV150 mm <sup>2</sup> (46 mm OD) 3 core
	600V-CV500 mm <sup>2</sup> (38 mm OD)
	6KV-CVT500 mm <sup>2</sup> (45 mm OD)
Multi-core vinyl insulation cable	VVR150 mm <sup>2</sup> (47 mm OD) 3 core
Soft copper cable	IV500 mm <sup>2</sup> (35 mm OD)
Hard copper cable	150 mm <sup>2</sup> (21 mm OD)

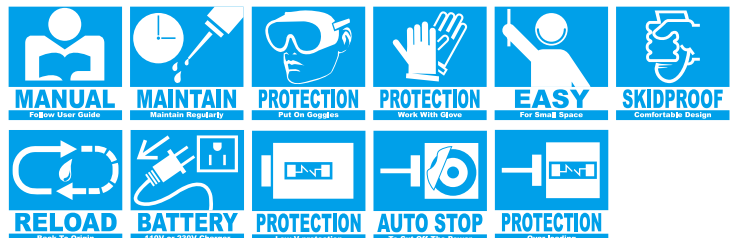

## ■ Model No. **LEC-54AC** (with Li-ion Battery & Charger)

Height : 390 mm

Weight : 3.4 kgs

## ■ Cutting Capacity:

- Max. Cable diameter:  
Nonferrous 54 mm

## ■ Specifications:

Drive unit : 14.4V DC Motor

Charger (BOSCH):

Input voltage : **LEC-54AC-120**

110V Single Phase AC

Input voltage : **LEC-54AC-230**

230V Single Phase AC

Input frequency : 50-60 Hz

Input current : 21.75 VA

## ■ Accessories:

- KuDos plastic carrying case
- 14.4V Battery, 110V or 230V Charger  
(See page 77)



※ For reference only

Model No.	Specification
	600V-CV325 mm <sup>2</sup> (31 mm OD)
Polyethylene cable	600V-CV150 mm <sup>2</sup> x 3(46 mm OD)
	600V-CV500 mm <sup>2</sup> (38 mm OD)
	6KV-CVT500 mm <sup>2</sup> (45 mm OD)
Multi-core vinyl insulation cable	VVR150 mm <sup>2</sup> (47 mm OD) 3 core
Soft copper cable	IV500 mm <sup>2</sup> (35 mm OD)
Hard copper cable	150 mm <sup>2</sup> (21 mm OD)



■ **Model No. REC-65** (with Ni-cd Battery & Charger)

Height : 360 mm

Weight : 4.0 kgs

■ **Cutting Capacity:**

- Max. Cable diameter:  
Nonferrous 65 mm

■ **Specifications:**

Drive unit : 14.4V DC Motor

Charger (GS/CE) :

Input voltage : **REC-65-120**

120V Single Phase AC

Input voltage : **REC-65-230**

230V Single Phase AC

Input frequency : 50-60 Hz

Input current : 21.75 VA

■ **Accessories:**

- KuDos plastic carrying case
- 14.4V Battery, 110V or 230V Charger  
(See page 77)



※ For reference only

Model No.	Specification
Polyethylene cable	600V-CV325 mm <sup>2</sup> (31 mm OD)
	600V-CV150 mm <sup>2</sup> (46 mm OD) 3 core
	600V-CV500 mm <sup>2</sup> (38 mm OD)
	6KV-CVT500 mm <sup>2</sup> (45 mm OD)
Multi-core vinyl insulation cable	VVR150 mm <sup>2</sup> (47 mm OD) 3 core
Soft copper cable	IV500 mm <sup>2</sup> (35 mm OD)
Hard copper cable	150 mm <sup>2</sup> (21 mm OD)

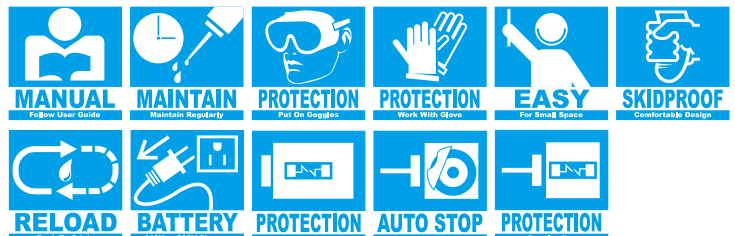

## ■ Model No. **LEC-65** (with Ni-cd Battery & Charger)

Height: 342 mm

Weight: 2.8 kgs (battery included)

## ■ Cutting Capacity:

- Max. Cable diameter:  
Nonferrous 65 mm

## ■ Specifications:

Drive unit: 14.4V DCMotor

Charger (BOCSH):

Input voltage: **LEC-65-120**

110V SinglePhaseAC

Input voltage: **LEC-65-230**

230V SinglePhaseAC

Input frequency: 50-60 Hz

Input current: 21.75 VA

## ■ Accessories:

- KuDos® plastic carrying case
- 14.4V Battery, 110V or 230V Charger  
(See page 77)



※ For reference only

Model No.	Specification
Polyethylene cable	600V-CV325 mm <sup>2</sup> (31 mm OD)
	600V-CV150 mm <sup>2</sup> (46 mm OD) 3 core
	600V-CV500 mm <sup>2</sup> (38 mm OD)
	6KV-CVT500 mm <sup>2</sup> (45 mm OD)
Multi-core vinyl insulation cable	VVR150 mm <sup>2</sup> (47 mm OD) 3 core
Soft copper cable	IV500 mm <sup>2</sup> (35 mm OD)
Hard copper cable	150 mm <sup>2</sup> (21 mm OD)





■ **Model No. REC-85CCP** (with Ni-cd Battery & Charger)

Height : 360 mm

Weight : 4.0 kgs

■ **Cutting Capacity:**

- Max. Cable diameter:  
85 mm CCP cable only

■ **Specifications:**

Drive unit : 14.4V DC Motor

Charger (GS/CE) :

Input voltage : **REC-85CCP-120**

120V Single Phase AC

Input voltage : **REC-85CCP-230**

230V Single Phase AC

Input frequency : 50-60 Hz

Input current : 21.75 VA

■ **Accessories:**

- KuDos plastic carrying case
- 14.4V Battery, 110V or 230V Charger  
(See page 77)



※ For reference only

Model No.	Specification
CCP cable	40-50 mm
	50-60 mm
	60-70 mm
	70-80 mm

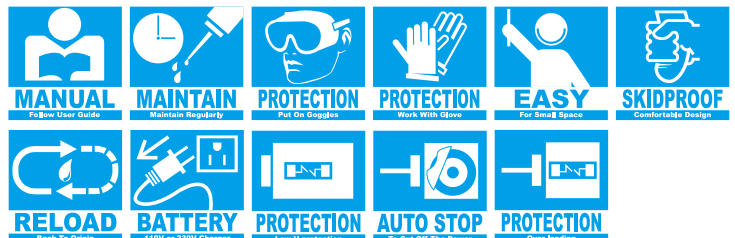

## ■ Close View of NEW KC series Features

● Gear rotated blade design.

### BRUSH DESIGN

● It can anti-dust & prevent impurities in the machine.



### SWITCH

● Forward → Neutral → Backward

### SAFETY SWITCH DESIGN

● Prevent missed operate the tool, It request to press both safety switch & switch to operate the tool.

● Ergonomic design and comfortable to use with anti-slip coated grip.

### SWITCH

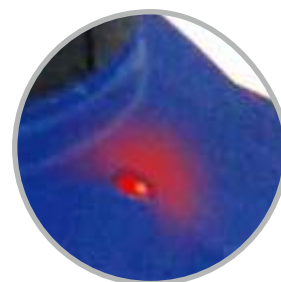

### OVERLOAD INDICATOR

● When red light flashed, It shows the battery was overloaded. When out of battery, The red light will light on.



● Bosch battery power indicator 14.4V Li-ion battery.



■ **Model No. KC-54** (with Li-ion Battery & Charger)

Height : 338 mm  
Weight : 3.4 kgs

■ **Cutting Capacity:**

- Max. Cable diameter:  
Nonferrous 54 mm & Steel supported  
400-pair telecom cable

■ **Specifications:**

Drive unit: 14.4V DC Motor  
Charger (BOCSH):  
Input voltage : **KC-54-120**  
110V Single Phase AC  
Input voltage : **KC-54-230**  
230V Single Phase AC  
Input frequency: 50-60 Hz  
Input current: 21.75 VA

■ **Accessories:**

- KuDos plastic carrying case
- 14.4V Battery, 110V or 230V Charger  
(See page 77)



※ For reference only

Model No.	Specification
Polyethylene cable	600V-CV325 mm <sup>2</sup> (31 mm OD)
Multi-core vinyl insulation cable	VVR150 mm <sup>2</sup> (47 mm OD) 3 core
SB-ACSR	ACSR120 mm <sup>2</sup> (18.6 mm OD) ACSR shall under steel of 2.0mm
Hard aluminum cable	HAL-OC400 mm <sup>2</sup> (31.9mm OD)
Hard copper cable	OE-OC150 mm <sup>2</sup> (21 mm OD)
SS cable	0.4 mm 400 CCP-F-SS(CR) cable

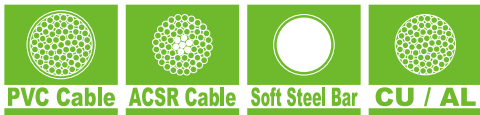



■ **Model No. KC-54AC** (with Li-ion Battery & Charger)

Height : 337 mm  
Weight : 3.4 kgs

■ **Cutting Capacity:**

• Max. Cable diameter:  
Nonferrous 54 mm

■ **Specifications:**

Drive unit: 14.4V DC Motor  
Charger (BOCSH):  
Input voltage : **KC-54AC-120**  
110V Single Phase AC  
Input voltage : **KC-54AC-230**  
230V Single Phase AC  
Input frequency: 50-60 Hz  
Input current: 21.75 VA

■ **Accessories:**

• KuDos plastic carrying case  
• 14.4V Battery, 110V or 230V Charger  
(See page 77)



※ For reference only

Model No.	Specification
Polyethylene cable	600V-CV325 mm <sup>2</sup> (31 mm OD)
	600V-CV150 mm <sup>2</sup> x 3(46 mm OD)
	600V-CV500 mm <sup>2</sup> (38 mm OD)
	6KV-CVT500 mm <sup>2</sup> (45 mm OD)
Multi-core vinyl insulation cable	VVR150 mm <sup>2</sup> (47 mm OD) 3 core
Soft copper cable	IV500 mm <sup>2</sup> (35 mm OD)
Hard copper cable	150 mm <sup>2</sup> (21 mm OD)





■ **Model No. KC-50** (with Li-ion Battery & Charger)

Height : 317 mm  
Weight : 2.6 kgs

■ **Cutting Capacity:**

- Max. Cable diameter:  
Nonferrous 50 mm

■ **Specifications:**

Drive unit: 14.4V DC Motor  
Charger (BOCSH):  
Input voltage : **KC-50-120**  
110V Single Phase AC  
Input voltage : **KC-50-230**  
230V Single Phase AC  
Input frequency: 50-60 Hz  
Input current: 21.75 VA

■ **Accessories:**

- KuDos plastic carrying case
- 14.4V Battery, 110V or 230V Charger  
(See page 77)



※ For reference only

Model No.	Specification
	600V-CV325 mm <sup>2</sup> (31 mm OD)
Polyethylene cable	600V-CV150 mm <sup>2</sup> x 3(46 mm OD)
	600V-CV500 mm <sup>2</sup> (38 mm OD)
	6KV-CVT500 mm <sup>2</sup> (45 mm OD)
Multi-core vinyl insulation cable	VVR150 mm <sup>2</sup> (47 mm OD) 3 core
Soft copper cable	IV500 mm <sup>2</sup> (35 mm OD)
Hard copper cable	150 mm <sup>2</sup> (21 mm OD)

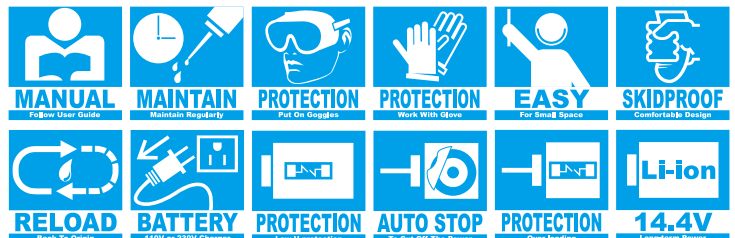

## ■ Close View of NEW K series Features

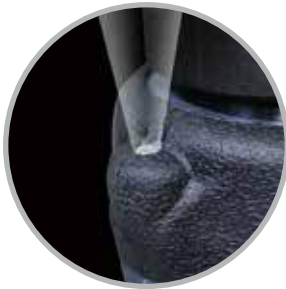

●LED light support



●Swivel head lock pin design allow user crimping / cutting easily



●Light weight and easy to use by single hand at narrow working space



●Retractable on high pressure stage



●Ergonomic design and comfortable to use with anti-slip coated grip



●18V Li-ion battery



- Low-voltage protection for extending battery life cycle
- Motor brake function as terminated immediately when completed operation
- Over voltage protection system to avoid motor damage or over heating



**LED**  
Illumination



**18V**  
Long-term Power



**MANUAL**  
Follow User Guide



**MAINTAIN**  
Maintain Regularly



**PROTECTION**  
Put On Goggles



**PROTECTION**  
Work With Glove



**EASY**  
For Small Space



**SKIDPROOF**  
Comfortable Design



**ROTATABLE**  
Head Rotation



**RELOAD**  
Back To Origin



**BATTERY**  
110V or 230V Charger



**PROTECTION**  
Low V protection



**AUTO STOP**  
To Cut Off The Power



**PROTECTION**  
Check Charging



■ **Model No. K-50** (with Li-ion Battery & Charger)

Length : 427 mm / Wt.: 3.5 kgs(w/o battery)  
Weight : 3.9 kgs (2.0Ah battery included)

■ **Specifications:**

Drive unit: 18V DC Motor  
Charger (GS/CE):  
Input voltage : 110V Single Phase AC  
Input voltage : 230V Single Phase AC  
Input frequency : 50-60 Hz  
Reservoir capacity : 48 cc

■ **Crimping Capacity:**

Max. Pressure : 520 bar  
Max Output : 5 tons / 49 kN  
Crimping Die Sets As Below  
(Sold Separately )



※ Above pressing jaws are sold separately.



<p><b>LED</b> Illumination</p>		<p><b>Li-ion</b> Long-term Power</p>	
<p><b>MANUAL</b> Follow User Guide</p>	<p><b>MAINTAIN</b> Maintain Regularly</p>	<p><b>PROTECTION</b> Put On Goggles</p>	<p><b>PROTECTION</b> Work With Glove</p>
<p><b>EASY</b> For Small Space</p>	<p><b>SKIDPROOF</b> Comfortable Design</p>	<p><b>350°</b> Head Rotation</p>	<p><b>RELOAD</b> Back To Origin</p>
<p><b>BATTERY</b> 110V or 230V Charger</p>	<p><b>PROTECTION</b> Low V protection</p>	<p><b>AUTO STOP</b> To Cut Off The Power</p>	<p><b>PROTECTION</b> Overloading</p>

## ■ Model No. **K-50 Die Set**

Weight : 3.0 kgs

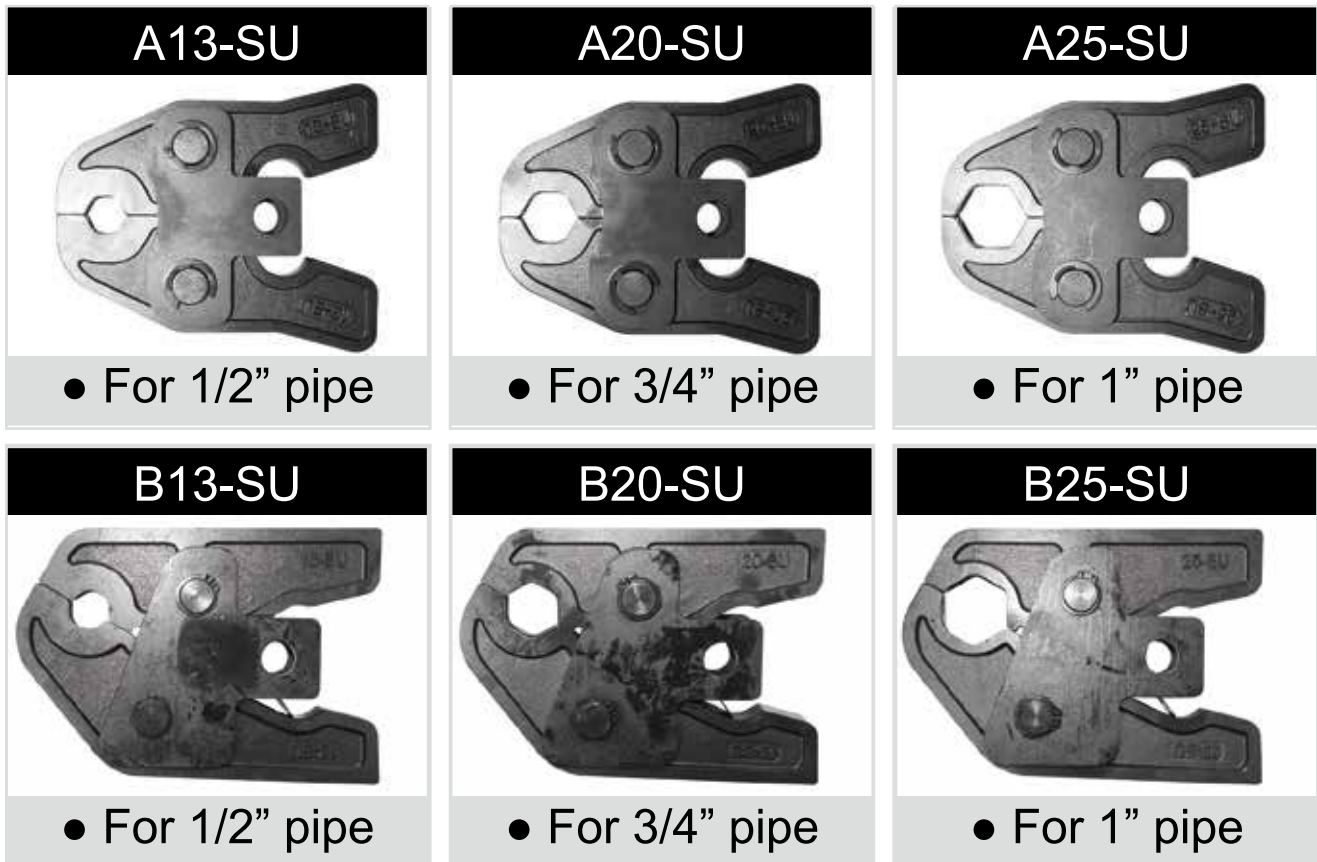

※(Standard JIS G3448)

## ■ Exchange The Die Set Operate Procedure







## ■ Model No. **K-150** (with Li-ion Battery & Charger)

Length: 328 mm / Wt.: 1.9 kgs(w/o battery)

Weight: 2.3 kgs (2.0Ah battery included)

### ■ Specifications:

Drive unit: 18V DC Motor

Charger (GS/CE):

Input voltage : 110V Single Phase AC

Input voltage : 230V Single Phase AC

Input frequency : 50-60 Hz

Reservoir capacity : 48 cc

### ■ Crimping Capacity:

Max. Pressure: 420 bar

Max Output: 4.0 tons / 39 kN

Max. Compression: 150 mm<sup>2</sup> copper

Accepts BEKU type dies

Stock Dies are for DIN 46235 Terminals

Dies sold separately

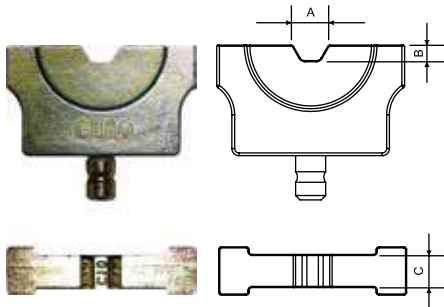

DIE NO.	A	B	C	Unit : mm
K150-CU-6	5.7	2.5	6.0	
K150-CU-10	6.4	2.8	6.0	
K150-CU-16	7.1	3.1	6.0	
K150-CU-25	8.7	3.8	6.0	
K150-CU-35	10.6	4.6	6.0	
K150-CU-50	12.0	5.2	6.0	
K150-CU-70	13.3	5.8	6.0	
K150-CU-95	16.4	7.1	6.0	
K150-CU-120	18.9	8.2	6.0	
K150-CU-150	21.0	9.1	6.0	

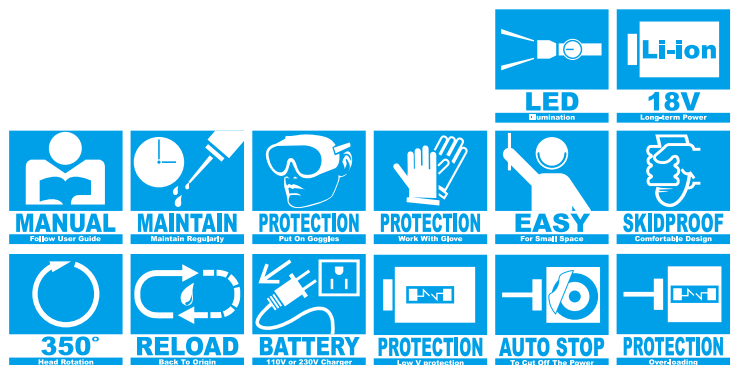

# BATTERY OPERATED TOOLS

## ■ Model No. **K-BGD3** (with Li-ion Battery & Charger)

Length : 459 mm / Wt.: 3.0 kgs(w/o battery)  
Weight : 3.4 kgs (2.0Ah battery included)

## ■ Specifications:

Drive unit: 18V DC Motor  
Charger (GS/CE):  
Input voltage : 110V Single Phase AC  
Input voltage : 230V Single Phase AC  
Input frequency : 50-60 Hz  
Reservoir capacity : 40 cc

## ■ Crimping Capacity:

Max. Pressure : 460 bar  
Max. Output : 6 tons / 58 kN

## ■ Features:

- Proper crimps are assured with butting steel jaws.
- Increased strength and greater bearing area is provided with larger steel bolts.
- Fast, easy, one-hand die insertion.
- No lost dies with spring loaded positive lock die retainer buttons.
- Full crimp force assured with over center cam action.
- Operator protection provided with butt stops and heat shrinktubing.
- Long life expectancy provided with fiberglass handles and light weight high strength aluminum alloy castings.
- The "D3" groove accommodates the line of type "W"-die inserts.

## ■ Connector Range:

- Copper, Aluminum, ACSR, Copperweld, Alumoweld, Steel, 6201, 5005, Compressed and Compact conductors.
- Copper Taps: # 10 sol.-2/0 str.
- Aluminum, ACSR Taps: # 14 sol. -4/0 ACSR
- Stirrups: # 6 ACSR-4/0 ACSR
- Overhead Full Tension Deadend, Full Tension Splices, Non Tension Splices, and Terminals Conductor Range: # 10 str. -4/0 ACSR
- Code conductor connectors: # 6-4/0 str. Copper and Aluminum

KuDos KW-dies	Burndy W-Dies	KuDos KW-dies	Burndy W-Dies
KW-BG	W-BG	KW-165	W-165
KW-O	W-O	KW-166	W-166
KW-C	W-C	KW-171	W-171
KW-K840	W-K840	KW-237	W-237
KW-161	W-161	KW-243	W-243
KW-162	W-162	KW-247	W-247
KW-163	W-163	KW-249	W-249
KW-164	W-164	KW-702	W-702

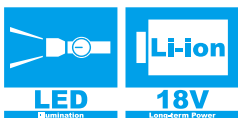

■ **Model No. K-10C** (with Li-ion Battery & Charger)



Length: 333 mm / Wt.: 1.5 kgs(w/o battery)  
Weight: 1.9 kgs (2.0Ah battery included)

■ **Specifications:**

Drive unit: 18V DC Motor  
Charger (GS/CE):  
Input voltage : 110V Single Phase AC  
Input voltage : 230V Single Phase AC  
Input frequency : 50-60 Hz  
Reservoir capacity : 40 cc

■ **Crimping Capacity:**

Max. Pressure: 380 bar  
Max Output: 1.5 tons / 14.7 kN

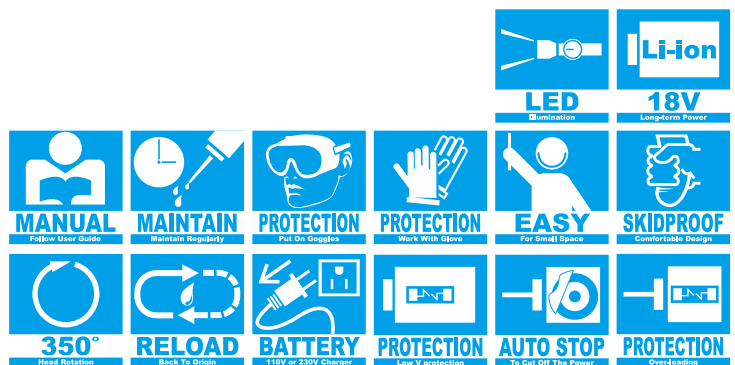

# BATTERY OPERATED TOOLS

## ■ Model No. **K-120** (with Li-ion Battery & Charger)

Length: 356 mm / Wt.: 2.3 kgs(w/o battery)

Weight: 2.7 kgs (2.0Ah battery included)



## ■ Specifications:

Drive unit: 18V DC Motor

Charger (GS/CE):

Input voltage : 110V Single Phase AC

Input voltage : 230V Single Phase AC

Input frequency : 50-60 Hz

Reservoir capacity : 40 cc

## ■ Crimping Capacity:

Max. Pressure: 700 bar

Max Output: 2.7 tons / 26.5N

Max. Compression: 16 mm<sup>2</sup> ~ 120 mm<sup>2</sup> copper

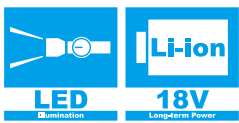



■ **Model No. K-ED10** (with Li-ion Battery & Charger)

Length: 410 mm / Wt.: 3.5 kgs(w/o battery)  
Weight: 3.9 kgs (2.0Ah battery included)

■ **Specifications:**

Drive unit: 18V DC Motor  
Charger (GS/CE):  
Input voltage : 110V Single Phase AC  
Input voltage : 230V Single Phase AC  
Input frequency : 50-60 Hz  
Reservoir capacity : 48 cc

■ **Crimping Capacity:**

Max. Pressure: 700 bar  
Max Output: 6.7 tons / 66 kN



<p><b>LED</b> Illumination</p>		<p><b>Li-ion</b> 18V Long-term Power</p>	
<p><b>MANUAL</b> Follow User Guide</p>	<p><b>MAINTAIN</b> Maintain Regularly</p>	<p><b>PROTECTION</b> Put On Goggles</p>	<p><b>PROTECTION</b> Work With Glove</p>
<p><b>EASY</b> For Small Space</p>	<p><b>SKIDPROOF</b> Comfortable Design</p>	<p><b>350°</b> Hand Rotation</p>	<p><b>RELOAD</b> Back To Origin</p>
<p><b>BATTERY</b> 110V or 230V Charger</p>	<p><b>PROTECTION</b> Low V protection</p>	<p><b>PROTECTION</b> Overheating</p>	

## ■ Model No. K-ED10 (Related heads)

### **KED10-PM** Hole Punch Adapter

Ram Stroke: 25mm  
Max. Output: 6.7tons/66kN  
Draw Stud (3/4")



### **KED10-RC** Cutting Dies For DIN Rails

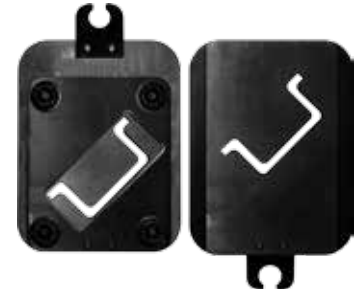
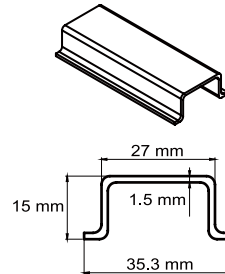

### **KED10-CR-5** Adapter For Crimping Dies

Dies sold separately  
(See page 151)  
(AHE 1016 /  
2535 / 5070 /  
95120 / 150 /  
185)



### **KED10-CR-9** Adapter For Crimping Dies

Dies sold separately  
(See page 155)  
(UCP240-14 /  
UCP240-15 /  
UCP240-16)



### **KED10-CR-12** Adapter For Crimping Dies

Dies sold separately  
(See page 152)  
(T16 / 25 / 35 /  
50 / 70 / 95 /  
120 / 150 /  
185 / 240)

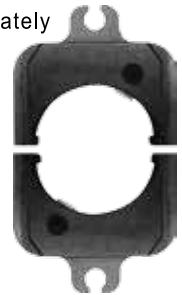

### **KED10-BC85** Railway Cutter For BC - Style Catenary Wires

Head in 4 sizes :

- 85 mm<sup>2</sup>
- 110 mm<sup>2</sup>
- 120 mm<sup>2</sup>
- 150 mm<sup>2</sup>



### **KED10-TRM5** Cutting Dies For Threaded Rods

Head in 8 types :

- M5 x 0.8
- M6 x 1.0
- M8 x 1.25
- M10 x 1.5
- M12 x 1.5
- 1/4"-20
- 3/8"-16
- 1/2"-13



### **KED10-NYY** Cutting Dies For Cutting Multi-Stranded Cu And Al Conductors Without Armouring

In conjunction with  
K-ED10 is max. 25 mm dia



### **KED10-ACSR** ACSR Cutting Die For Al/Cu Conductors

In conjunction with  
K-ED10 is max. 25 mm dia

For ACSR conductors to  
EN DIN 50182 and  
high-tensile steel cables



※ Available for 7 interchangeable adapters and continuous with more optional adapters under developing will be coming soon !

## ■ Model No. **K-185** (with Li-ion Battery & Charger)

Length: 360 mm / Wt.: 2.1 kgs(w/o battery)

Weight: 2.5 kgs (2.0Ah battery included)

## ■ Specifications:

Drive unit: 18V DC Motor

Charger (GS/CE):

Input voltage : 110V Single Phase AC

Input voltage : 230V Single Phase AC

Input frequency : 50-60 Hz

Reservoir capacity : 48 cc

## ■ Crimping Capacity:

Max. Pressure: 460 bar

Max Output: 5.3 tons / 52 kN

Max. Compression: 185 mm<sup>2</sup> copper

Accepts BEKU type dies

Stock Dies are for DIN 46235 Terminals

Dies sold separately (See page 151)

(AHE 1016/2535/5070/95120/150/185)

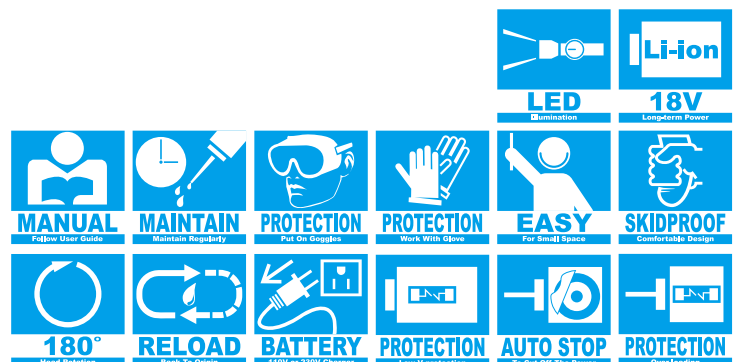

## ■ Model No. **K-240** (with Li-ion Battery & Charger)

Length: 354 mm / Wt.: 2.3 kgs(w/o battery)

Weight: 2.7 kgs (2.0Ah battery included)

## ■ Specifications:

Drive unit: 18V DC Motor

Charger (GS/CE):

Input voltage : 110V Single Phase AC

Input voltage : 230V Single Phase AC

Input frequency : 50-60 Hz

Reservoir capacity : 48 cc

## ■ Crimping Capacity:

Max. Pressure: 460 bar

Max Output: 5.3 tons / 52 kN

Max. Compression: 240 mm<sup>2</sup> copper

Accepts BEKU type dies

Stock Dies are for DIN 46235 Terminals

Dies sold separately (See page 151)

(AHE 1016/2535/5070/95120/150/185/240)

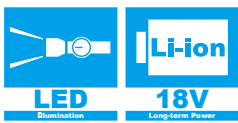



## ■ Model No. **K-PH240** (with Li-ion Battery & Charger)

Length: 359 mm / Wt.: 2.9 kgs(w/o battery)

Weight: 3.3 kgs (2.0Ah battery included)

### ■ Specifications:

Drive unit: 18V DC Motor

Charger (GS/CE):

Input voltage : 110V Single Phase AC

Input voltage : 230V Single Phase AC

Input frequency : 50-60 Hz

Reservoir capacity : 48 cc

### ■ Crimping Capacity:

Max. Pressure: 550 bar

Max Output: 6.2 tons / 61 kN

Max. Compression: 240 mm<sup>2</sup> copper  
Aluminum lugs

Accepts all dies used for Alcoa,  
Burndy, T&B, Klauke, Cembre and  
Blackburn 6 ton compressors

Dies sold separately (See page 152)  
(T16/25/35/50/70/95/120/150/185/240)

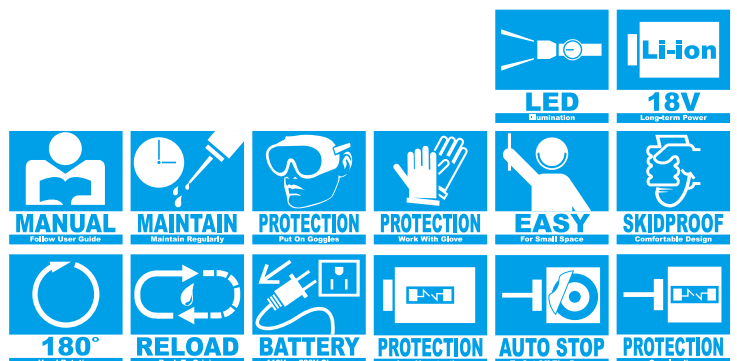

## ■ Model No. **K-20** (with Li-ion Battery & Charger)

Length : 329 mm / Wt.: 2.8 kgs(w/o battery)  
Weight : 3.2 kgs (2.0Ah battery included)

## ■ Specifications:

Drive unit: 18V DC Motor  
Charger (GS/CE):  
Input voltage : 110V Single Phase AC  
Input voltage : 230V Single Phase AC  
Input frequency : 50-60 Hz  
Reservoir capacity : 48 cc

## ■ Cutting Capacity:

Max. Pressure : 550 bar  
Oil Required : 24 cc  
Max. Output : 5.3 tons / 52 kN  
Wire rope 6x7 : 16 mm  
Wire rope 6x12 : 20 mm  
Wire rope 6x19 : 20 mm  
Soft Copper bar : 20 mm  
Soft aluminum bar : 16 mm  
Soft steel bar : 16 mm  
Reinforcing rod : 13 mm  
Cu strands : 20 mm  
Al strands : 20 mm  
ACSR Cable : 21 mm  
Guy wire 1x7 : 15 mm  
Guy wire 1x19 : 16 mm  
underground cable : 18 mm

**Cutting of piano wire is prohibited.**

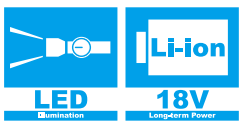

■ **Model No. K-24** (with Li-ion Battery & Charger)

Length : 344 mm / Wt.: 2.8 kgs(w/o battery)  
Weight : 3.2 kgs (2.0Ah battery included)

■ **Specifications:**

Drive unit: 18V DC Motor  
Charger (GS/CE):  
Input voltage : 110V Single Phase AC  
Input voltage : 230V Single Phase AC  
Input frequency : 50-60 Hz  
Reservoir capacity : 48 cc

■ **Cutting Capacity:**

Max. Pressure : 700 bar  
Oil Required : 25 cc  
Max. Output : 6.7 tons / 66 kN  
Wire rope 6x7 : 24 mm  
Wire rope 6x12 : 24 mm  
Wire rope 6x19 : 24 mm  
Soft Copper bar : 23 mm  
Soft aluminum bar : 24 mm  
Soft steel bar : 16 mm  
Cu strands : 24 mm  
Al strands : 24 mm  
ACSR : 24 mm

**Cutting of piano wire is prohibited.**

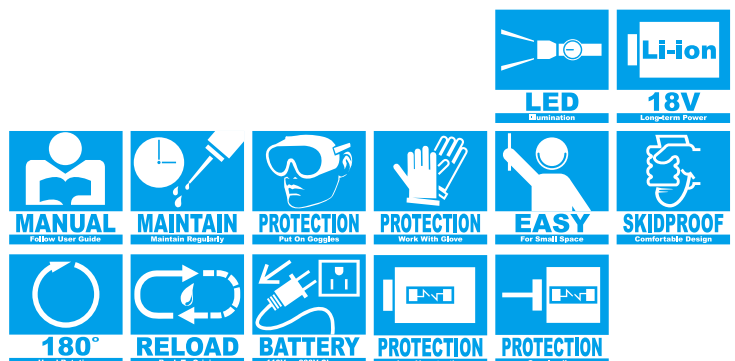
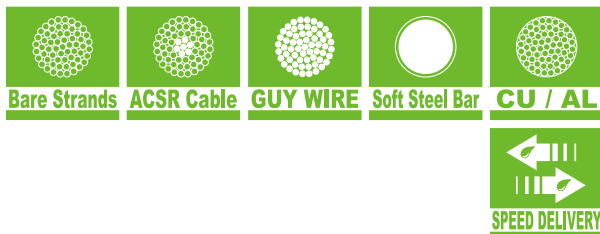

■ **Model No. K-S24** (with Li-ion Battery & Charger)

Length : 356 mm / Wt.: 3.7 kgs(w/o battery)  
Weight : 4.1 kgs (2.0Ah battery included)

■ **Specifications:**

Drive unit: 18V DC Motor  
Charger (GS/CE):  
Input voltage : 110V Single Phase AC  
Input voltage : 230V Single Phase AC  
Input frequency : 50-60 Hz  
Reservoir capacity : 48 cc

■ **Cutting Capacity:**

Max. Pressure : 700 bar  
Oil Required : 31 cc  
Max Output : 8.0 tons / 78 kN  
Wire rope 6x7 : 18 mm  
Wire rope 6x12 : 24 mm  
Wire rope 6x19 : 24 mm  
Soft steel bar : 20 mm  
Reinforcing rod : 16 mm  
Cu strands : 24 mm  
Al strands : 24 mm  
ACSR Cable : 24 mm  
Guy wire 1x7 : 20 mm  
Guy wire 1x19 : 20 mm  
**Cutting of piano wire is prohibited.**

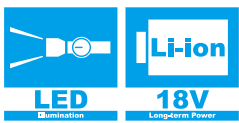

■ **Model No. K-30A** (with Li-ion Battery & Charger)

Length : 412 mm / Wt.: 3.6 kgs(w/o battery)  
Weight : 4.0 kgs (2.0Ah battery included)



■ **Specifications:**

Drive unit: 18V DC Motor  
Charger (GS/CE):  
Input voltage : 110V Single Phase AC  
Input voltage : 230V Single Phase AC  
Input frequency : 50-60 Hz  
Reservoir capacity : 48 cc

■ **Cutting Capacity:**

Max. Pressure : 700 bar  
Max. Output : 7.9 tons / 77.8 kN  
Cu Strands : 28 mm  
Al Strands : 28 mm  
ACSR : 19 mm  
Telephone Cable : 30 mm  
CCP Cable : 30 mm  
Underground Cable : 30 mm  
**Cutting of piano wire is prohibited.**

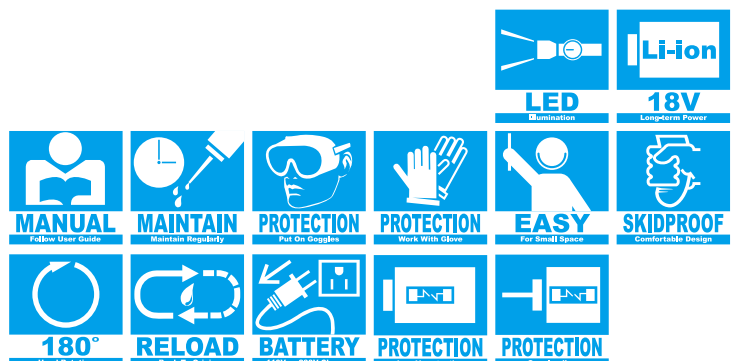
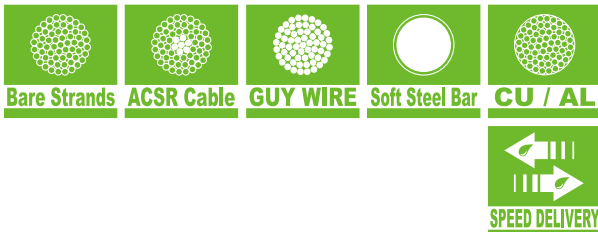

## BATTERIES

### ■ Model No. **BAT-12V**

#### ■ Specifications:

Output voltage : 12V  
Capacity : 1.2 Ah

#### ■ Use for:

REC-50



### ■ Model No. **BAT-14.4V**

#### ■ Specifications:

Output voltage : 14.4V  
Capacity : 2.0 Ah

#### ■ Use for:

REC-54  
REC-54AC  
REC-65  
REC-85CCP



### ■ Model No. **LEC-14.4V**

#### ■ Specifications:

Output voltage : 14.4V  
Capacity : 3.0 Ah

#### ■ Use for:

LEC-series



### ■ Model No. **K-18V**

#### ■ Specifications:

Output voltage : 18V  
Capacity : 2.0 Ah \ 4.0 Ah

#### ■ Use for:

K-series  
CEP-15SS



## CHARGERS

### ■ Model No. **ABC-10A**

#### ■ Specifications:

Input voltage : 115V AC 50-60Hz 40W  
Output : 15V DC 1.5A

#### ■ Use for:

BAT-12V

### ■ Model No. **AD-B735**

#### ■ Specifications:

Input voltage : 120V AC 50-60Hz 40W  
Output : 18V DC 1.5A

#### ■ Use for:

BAT-14.4V

### ■ Model No. **LEC-110CHA**

#### ■ Specifications:

Input voltage : 115V AC 50-60Hz 140W  
Output : 10.8V DC 6A

#### ■ Use for:

LEC-14.4V \ K-18V

### ■ Model No. **ABC-10B**

#### ■ Specifications:

Input voltage : 230V AC 50-60Hz 40W  
Output : 15V DC 1.5A

#### ■ Use for:

BAT-12V

### ■ Model No. **AD-B734**

#### ■ Specifications:

Input voltage : 230V AC 50-60Hz 40W  
Output : 18V DC 1.5A

#### ■ Use for:

BAT-14.4V

### ■ Model No. **LEC-230CHA**

#### ■ Specifications:

Input voltage : 220V~240V AC 50-60Hz 140W  
Output : 10.8V~18V DC 6A

#### ■ Use for:

LEC-14.4V \ K-18V



## ■ Cutting Capacity Chart

Cutting Tools	Output (ton)	Ram Stroke (mm)	Weight (kg)	Cutting Capacity															
				Hempcore (mm)			Round Bar (mm)				Strands (mm)					Cable (mm)			
				6x7	6x12	6x19	Soft CU Bar	Soft AL Bar	Soft Steel Bar	Reinforcing Bar	Bare CU Strands	Bare AL inum Strands	ACSR	Guy Wire 1x7	Guy Wire 1x19	Telephone Cable CCP	Lead Sheath-ed Cable	Under-ground Cable	
HYSC-20	5.3	24.5	2.5	16	20	20	20	16	16			20	20	21	15	16			
HYSC-24	6.7	25.7	2.7	24	24	24	23	24	16			24	24	24	20	20			
S-24	8.0	28.0	4.2	18	24	24	24	18	20	16		32	24	24	20	20			24
HYSC-32	14.3	40.0	9.1	32	32	32	32	32	25	25		32	32	32	32	32			32
HYSC-45	9.7	51.0	6.8	40	40	40	32	40	20			40	40	40					
HYCC-050	5.0	53.4	3.9									50	50				50		
S-55	12.7	58.7	10.3	25	30	30	35	28	22	19		54	54	54	15	20			50
★ HYCC-P85	5.0	93.2	9.7									28	38				85	85	50
TC-085	5.6	90.4	8.5									85	85				85		
PC-8511	10.6	90.4	9.0									85	85				85		
YS-30A	8.0	20.0	4.0									28	28	19			30	30	30
★ HYCC-85YC	7.5	43.2	9.0									60	60				85	85	85

★ Except armoured cable

Cutting Heads	Output (ton)	Ram Stroke (mm)	Weight (kg)	Cutting Capacity																	
				Steel Wire Rope (mm)			Round Bar (mm)				Wire Strand (mm)					Cable (mm)					
				6x7	6x12	6x19	Soft CU Bar	Soft AL Bar	Soft Steel Bar	Reinforcing Bar	Bare CU Strands	Bare AL Strands	ACSR	Guy Wire 1x7	Guy Wire 1x19	Telephone Cable CCP	Lead Sheath-ed Cable	Under-ground Cable	CU Cables	AL Cables	
HYSC-20HE	6.7	24.5	2.0	16	20	20	40	16	16	13		20	20	21	15	16			18		
HYSC-24HE	8.0	27.6	2.1	24	24	24	23	24	16	13		23	24	24							
S-24HE	5.3	26.3	8.9	32	24	24	24	18	20	16		24	24	24	20	20			24		
HYSC-32HE	25.4	37.0	3.0	18	32	32	32	32	25	25		32	32	32	32	32			32		
HYSC-45HE	9.7	51.5	4.5	40	40	40	32	40	20			40	40	40							
HYCC-35HE	6.4	73.0	3.5									35	35								
HYCC-050HE	5.0	53.4	3.2									50	50				50				
S-55HE	12.7	58.7	7.2	25	30	30	35	28	22	19		54	54	54	15	20			50		
HYSC-55HE	14.9	56.0	8.4	25	30	30	35	28	22	19		50	50	50	15	20			50		
★ HYCC-P85HE	5.0	93.2	6.8									28	38				85	85	50		
TC-085HE	5.6	90.4	4.9									85	85				85				
HYCC-P100HE	8.8	109.3	12.7									42	46				100				
HYCC-105HE	10.2	122.8	13.2									42	46				105				
TC-120HE	10.6	124.6	9.6									120	120				120				
YS-30AHE	7.9	20.1	3.0									28	28				30	30	30		
HYCC-065HE	7.5	68.2	4.9									60	60				65				
HYCC-075S	20.0	56.5	9.0									75	75								
★ HYCC-096S	13.5	63.0	8.1																	95	95
★ P-85YC	7.5	43.4	5.0									60	60				85	85	85		

★ Except armoured cable

CU=Copper AL=Aluminum

# CUTTERS

## ■ Model No. **HYSC-20**

Length : 344 mm  
Weight : 2.5 kgs

## ■ Specifications:

Max. Pressure : 700 bar  
Oil Required : 22 cc  
Max Output : 5.3 tons / 52 kN

## ■ Cutting Capacity:

Wire rope 6x7 : 16 mm  
Wire rope 6x12 : 20 mm  
Wire rope 6x19 : 20 mm  
Soft copper bar : 20 mm  
Soft aluminum bar : 16 mm  
Underground cable : 18 mm  
Soft steel bar : 16 mm  
Reinforcing rod : 13 mm  
Cu strands : 20 mm  
Al strands : 20 mm  
ACSR : 21 mm  
Guy wire 1x7 : 15 mm  
Guy wire 1x19 : 16 mm

**Cutting of piano wire is prohibited.**

## ■ Features:

- 180° rotating head for convenient operation.
- Superior guillotine type cutting for less jamming than shear type cutters.
- Single stage pumping action.
- All blades are easily replaceable.
- Flip-top latch for easy insertion of cutting material.
- Single stage pump action with spring return.
- No set-up time required.
- Lightweight, self-contained tool, can be used anywhere.

## ■ Accessories:

Carrying Bag



HYSC-20 #64	Moving Blade
HYSC-20 #55	Fixed Blade





## ■ Model No. **HYSC-24**

Length : 360 mm

Weight : 2.7 kgs

## ■ Specifications:

Max. Pressure : 700 bar

Oil Required : 25 cc

Max. Output : 6.7 tons / 66 kN

## ■ Cutting Capacity:

Wire rope 6x7 : 24 mm

Wire rope 6x12 : 24 mm

Wire rope 6x19 : 24 mm

Soft copper bar : 23 mm

Soft aluminum bar : 24 mm

Soft steel bar : 16 mm

Cu strands : 24 mm

Al strands : 24 mm

ACSR : 24 mm

(Note : Tensile strength (daN/mm<sup>2</sup>) ≤ 180)

**Cutting of piano wire is prohibited.**

## ■ Features:

- 180° rotating head for convenient operation.
- Superior guillotine type cutting for less jamming than shear type cutters.
- Single stage pumping action.
- All blades are easily replaceable.
- Flip-top latch for easy insertion of cutting material.
- Single stage pump action with spring return.
- No set-up time required.
- Lightweight, self-contained tool, can be used anywhere.

## ■ Accessories:

Carrying Bag



HYSC-24 #11	Moving Blade
HYSC-24 #3	Fixed Blade



# CUTTERS

## ■ Model No. S-24

Length : 425 mm

Weight : 4.2 kgs

## ■ Specifications:

Max. Pressure : 700 bar

Oil Required : 32 cc

Max. Output : 8 tons / 78 kN

## ■ Cutting Capacity:

Wire rope 6x7 : 18 mm

Wire rope 6x12 : 24 mm

Wire rope 6x19 : 24 mm

Soft steel bar : 20 mm

Reinforcing rod : 16 mm

Cu strands : 24 mm

Al strands : 24 mm

ACSR : 24 mm

Guy wire 1x7 : 20 mm

Guy wire 1x19 : 20 mm

Underground cable : 24 mm

**Cutting of piano wire is prohibited.**

## ■ Features:

- 180° rotating head for convenient operation.
- Superior guillotine type cutting for less jamming than shear type cutters.
- Two stage pumping action.
- All blades are easily replaceable.
- Flip-top latch for easy insertion of cutting material.
- Single stage pump action with spring return.
- No set-up time required.
- Lightweight, self-contained tool, can be used anywhere.
- One spare cutting blade can be stored inside of the moveable handle.

## ■ Accessories:

Carrying Bag



S-24 #56	Moving Blade
S-24 #55	Fixed Blade

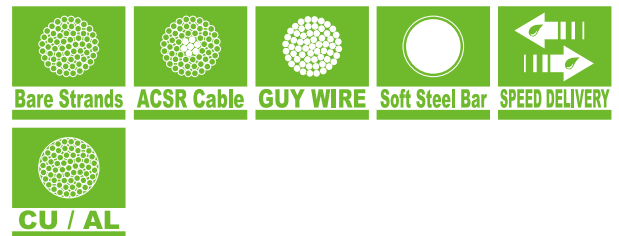

## ■ Model No. **HYSC-32**

Length : 580 mm

Weight : 9.1 kgs

### ■ Specifications:

Max. Pressure : 700 bar

Oil Required : 84 cc

Max. Output : 14.3 tons / 141 kN

### ■ Cutting Capacity:

Wire rope 6x7 : 32 mm

Wire rope 6x12 : 32 mm

Wire rope 6x19 : 32 mm

Soft steel bar : 25 mm

Reinforcing rod : 25 mm

Cu strands : 32 mm

Al strands : 32 mm

ACSR : 32 mm

Guy wire 1x7 : 32 mm

Guy wire 1x19 : 32 mm

Underground cable : 32 mm

**Cutting of piano wire is prohibited.**

### ■ Features:

- Single Stage Pumping action.
- 180° rotating head for convenient operation.
- Superior guillotine type cutting for less jamming than shear type cutters.
- All blades are easily replaceable.
- Flip-top latch for easy insertion of cutting material.
- Spring return.
- No set-up required.
- Lightweight, self-contained tool, can be used anywhere.

### ■ Accessories:

Carrying Bag



HYSC-32 #56	Moving Blade
HYSC-32 #53	Fixed Blade



# CUTTERS

## ■ Model No. **HYSC-45**

Length : 683 mm

Weight : 6.8 kgs

## ■ Specifications:

Max. Pressure : 700 bar

Oil Required : 70 cc

Max. Output : 9.7 tons / 95 kN

## ■ Cutting Capacity:

Wire rope 6x7 : 40 mm

Wire rope 6x12 : 40 mm

Wire rope 6x19 : 40 mm

Soft copper bar : 32 mm

Soft aluminum bar : 40 mm

Soft steel bar : 20 mm

Cu strands : 40 mm

Al strands : 40 mm

ACSR : 40 mm

**Cutting of piano wire is prohibited.**

## ■ Features:

- Light weight portable hydraulic cutter features.
- Single action cylinder with spring return.
- Guillotine type cutting for less jamming than shear type cutting.
- No set-up time required.
- Blades are easily replaceable.
- 180° swivel and lock pin type head allows easy cutting position.

## ■ Accessories:

Carrying Bag



HYSC-45 #8	Moving Blade
HYSC-45 #2	Fixed Blade

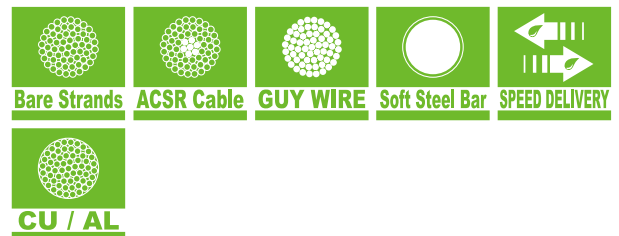

## ■ Model No. **HYCC-050**

Length : 486 mm

Weight : 3.9 kgs

### ■ Specifications:

Max. Pressure : 700 bar

Oil Required : 39 cc

Max. Output : 5 tons / 49 kN

### ■ Cutting Capacity:

Cu strands : 50 mm

Al strands : 50 mm

CCP cable : 50 mm

**Cutting of piano wire is prohibited.**

### ■ Features:

- 180° rotating head for convenient operation.
- Superior guillotine type cutting for less jamming than shear type cutters.
- Single stage pumping action.
- All blades are easily replaceable.
- Flip-top latch for easy insertion of cutting material.
- Spring return.
- No set-up time required.
- Lightweight, self-contained tool, can be used anywhere.

### ■ Accessories:

Carrying Bag



HYCC-050 #10	Moving Blade
HYCC-050 #1	Fixed Blade



# CUTTERS

## ■ Model No. S-55

Length : 631 mm  
Weight : 10.3 kgs

## ■ Specifications:

Max. Pressure : 700 bar  
Oil Required : 107 cc  
Max. Output : 12.7 tons / 124.5 kN

## ■ Cutting Capacity:

Wire rope 6x7 : 25 mm  
Wire rope 6x12 : 30 mm  
Wire rope 6x19 : 30 mm  
Soft copper bar : 35 mm  
Soft aluminum bar : 28 mm  
Soft steel bar : 22 mm  
Reinforcing rod : 19 mm  
Cu strands : 54 mm  
Al strands : 54 mm  
ACSR : 54 mm  
Guy wire 1x7 : 15 mm  
Guy wire 1x19 : 20 mm  
Underground cable : 50 mm

**Cutting of piano wire is prohibited.**

## ■ Features:

- Light weight portable hydraulic cutter features.
- Single action cylinder with spring return.
- Guillotine type cutting for less jamming than shear type cutting.
- No set-up time required.
- Blades are easily replaceable.
- 180° swivel and lock pin type head allows easy cutting position.

## ■ Accessories:

Carrying Bag



S-55 #70	Moving Blade
S-55 #87	Fixed Blade

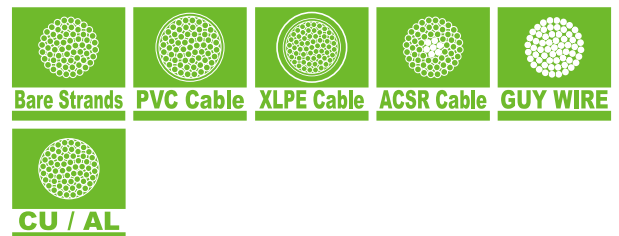

## ■ Model No. **HYCC-P85**

Length : 716 mm

Weight : 9.7 kgs

### ■ Specifications:

Max. Pressure : 700 bar

Oil Required : 66 cc

Max. Output : 5 tons / 49 kN

### ■ Cutting Capacity:

Cu strands : 28 mm

Al strands : 38 mm

CCP cable : 85 mm

Underground cable : 50 mm (Except armoured cable)

**Cutting of piano wire is prohibited.**

### ■ Features:

- Lock pin type cutting head.
- Two stage pumping action for rapid blade advance.
- 180° rotating head for convenient operation.
- Superior guillotine type cutting for of less jamming than shear type cutters.
- All blades are easily replaceable.
- Spring return.
- No set-up time required.
- Light weight, self-contained tool, can be used anywhere.

### ■ Accessories:

Carrying Bag



HYCC-P85 #57	Moving Blade
HYCC-P85 #39	Fixed Blade



# CUTTERS

## ■ Model No. TC-085

Length : 667 mm

Weight : 8.5 kgs

## ■ Specifications:

Max. Pressure : 700 bar

Oil Required : 163 cc

Max. Output : 5.6 tons / 56 kN

## ■ Cutting Capacity:

Cu strands : 85 mm

Al strands : 85 mm

CCP cable : 85 mm

**Cutting of piano wire is prohibited.**

## ■ Features:

- Two stage pumping action for rapid blade advance.
- 180° rotating head for convenient operation.
- Superior guillotine type cutting for less jamming than shear type cutters.
- All blades are easily replaceable.
- Flip-top latch for easy insertion of cutting material.
- Spring return.
- No set-up required.
- Lightweight, self-contained tool, can be used anywhere.

## ■ Accessories:

Carrying Bag



TC-085 #15	Moving Blade
TC-085 #1	Fixed Blade





## ■ Model No. **PC-8511**

Length : 681 mm

Weight : 9.0 kgs

### ■ Specifications:

Max. Pressure : 700 bar

Oil Required : 168 cc

Max. Output : 10.6 tons / 104.3 kN

### ■ Cutting Capacity:

Cu cable : 85 mm

Al cable : 85 mm

CCP cable : 85 mm

**Cutting of piano wire is prohibited.**

### ■ Features:

- Two stage pumping action for rapid blade advance.
- 180° rotating head for convenient operation.
- Superior guillotine type cutting for less jamming than shear type cutters.
- All blades are easily replaceable.
- Flip-top latch for easy insertion of cutting material.
- Spring return.
- No set-up required.
- Lightweight, self-contained tool, can be used anywhere.

### ■ Accessories:

Carrying Bag



PC-8511 #58	Moving Blade
PC-8511 #57	Fixed Blade



# CUTTERS

## ■ Model No. **YS-30A**

Length : 481 mm

Weight : 4.0 kgs

## ■ Specifications:

Max. Pressure : 700 bar

Oil Required : 23 cc

Max. Output : 7.9 tons / 77.8 kN

## ■ Cutting Capacity:

Cu strands : 28 mm

Al strands : 28 mm

Telephone cable : 30 mm

Underground cable : 30 mm

ACSR : 19 mm

CCP cable : 30 mm

**Cutting of piano wire is prohibited.**

## ■ Features:

- Light weight portable hydraulic cutter features.
- Single action cylinder with spring return.
- Scissor type cutting for less jamming than shear type cutting.
- No set-up time required.
- Blades are easily replaceable.
- 180° degree swivel and lock pin type head allows easy cutting position.

## ■ Accessories:

Carrying Bag



YS-30A #7	Moving Blade
YS-30A #8	Moving Blade



## ■ Model No. **HYCC-85YC**

Length : 694 mm

Weight : 9.0 kgs

### ■ Specifications:

Max. Pressure : 700 bar

Oil Required : 80 cc

Max. Output : 7.5 tons / 73.7 kN

### ■ Cutting Capacity:

Cu cable : 60 mm

Al cable : 60 mm

CCP cable : 85 mm

Underground cable : 85 mm (Except armoured cable)

**Cutting of piano wire is prohibited.**

### ■ Features:

- Fast cutting with remote operation.
- Two stage pumping action for rapid blade advance.
- 180° rotating head plus an extra handle for easy carry and overhead convenient operation.
- No set-up required.

### ■ Accessories:

Carrying Bag



HYCC-85YC #64	Moving Blade
HYCC-85YC #65	Moving Blade



# CUTTERS

## ■ Model No. **HYSC-20HE**

Length : 240 mm

Weight : 2.0 kgs

## ■ Specifications:

Max. Pressure : 700 bar

Oil Required : 19 cc

Max. Output : 5.3 tons / 52 kN

## ■ Cutting Capacity:

Wire rope 6x7 : 16 mm

Wire rope 6x12 : 20 mm

Wire rope 6x19 : 20 mm

Soft copper bar : 20 mm

Soft aluminum bar : 16 mm

Underground cable : 18 mm

Soft steel bar : 16 mm

Reinforcing rod : 13 mm

Cu strands : 20 mm

Al strands : 20 mm

ACSR : 21 mm

Guy wire 1x7 : 15 mm

Guy wire 1x19 : 16 mm

**Cutting of piano wire is prohibited.**

## ■ Features:

- Fast cutting with remote operation.
- Operated any hydraulic pump with rated oil pressure of 700bar (10,000 psi).
- Single action piston/cylinder arrangement.
- Blades are easily replaceable.
- Flip-top latch for easy insertion of cutting material.
- Single action cylinder with spring return.

## ■ Accessories:

Carrying Bag



HYSC-20HE #2	Moving Blade
HYSC-20HE #17	Fixed Blade



## ■ Model No. **HYSC-24HE**

Length : 240 mm

Weight : 2.1 kgs

### ■ Specifications:

Max. Pressure : 700 bar

Oil Required : 27 cc

Max. Output : 6.7 tons / 66 kN

### ■ Cutting Capacity:

Wire rope 6x7 : 24 mm

Wire rope 6x12 : 24 mm

Wire rope 6x19 : 24 mm

Soft copper bar : 23 mm

Soft aluminum bar : 24 mm

Soft steel bar : 16 mm

Cu strands : 24 mm

Al strands : 24 mm

ACSR : 24 mm

(Note : Tensile strength (daN/mm<sup>2</sup>) ≤ 180)

**Cutting of piano wire is prohibited.**

### ■ Features:

- Superior guillotine type cutting for less jamming than shear type cutters.
- All blades are easily replaceable.
- Flip-top latch for easy insertion of cutting material.
- No set-up time required.
- Lightweight, self-contained tool, can be used anywhere.

### ■ Accessories:

Carrying Bag



HYSC-24HE #7	Moving Blade
HYSC-24HE #2	Fixed Blade



# CUTTERS

## ■ Model No. **S-24HE**

Length : 170 mm

Weight : 3.0 kgs

## ■ Specifications:

Max. Pressure : 700 bar

Oil Required : 30 cc

Max. Output : 8 tons / 78 kN

## ■ Cutting Capacity:

Wire rope 6x7 : 18 mm

Wire rope 6x12 : 24 mm

Wire rope 6x19 : 24 mm

Soft steel bar : 20 mm

Reinforcing rod : 16 mm

Cu strands : 24 mm

Al strands : 24 mm

ACSR : 24 mm

Guy wire 1x7 : 20 mm

Guy wire 1x19 : 20 mm

Soft copper bar : 24 mm

Soft aluminum bar : 18 mm

Underground cable : 24 mm

**Cutting of piano wire is prohibited.**

## ■ Features:

- Fast cutting with remote operation.
- Operated any hydraulic pump with rated oil pressure of 700bar (10,000 psi).
- Single action piston/cylinder arrangement.
- Blades are easily replaceable.
- Flip-top latch for easy insertion of cutting material.
- Single action cylinder with spring return.

## ■ Accessories:

Carrying Bag



S-24HE #13	Moving Blade
S-24HE #12	Fixed Blade



## ■ Model No. **HYSC-32HE**

Length : 300 mm

Weight : 8.9 kgs

### ■ Specifications:

Max. Pressure : 700 bar

Oil Required : 135 cc

Max. Output : 25.4 tons / 249 kN

### ■ Cutting Capacity:

Wire rope 6x7 : 32 mm

Wire rope 6x12 : 32 mm

Wire rope 6x19 : 32 mm

Soft steel bar : 25 mm

Reinforcing rod : 25 mm

Cu strands : 32 mm

Al strands : 32 mm

ACSR : 32 mm

Guy wire 1x7 : 32 mm

Guy wire 1x19 : 32 mm

Soft copper bar : 32 mm

Soft aluminum bar : 32 mm

Underground cable : 32 mm

**Cutting of piano wire is prohibited.**

### ■ Features:

- Functional handle for convenient operation.
- Fast cutting with remote operation.
- Operated any hydraulic pump with rated oil pressure of 700 bar(10,000psi).
- Single action piston/cylinder arrangement.
- Blades are easily replaceable.
- Flip-top latch for easy insertion of cutting material.
- Single action cylinder with spring return.

### ■ Accessories:

Carrying Bag

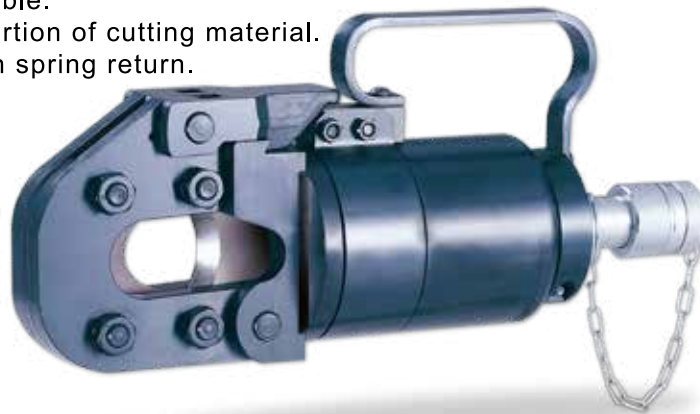

HYSC-32HE #13	Moving Blade
HYSC-32HE #2	Fixed Blade



# CUTTERS

## ■ Model No. **HYSC-45HE**

Length : 346 mm

Weight : 4.5 kgs

## ■ Specifications:

Max. Pressure : 700 bar

Oil Required : 72 cc

Max. Output : 9.7 tons / 95 kN

## ■ Cutting Capacity:

Wire rope 6x7 : 40 mm

Wire rope 6x12 : 40 mm

Wire rope 6x19 : 40 mm

Soft copper bar : 32 mm

Soft aluminum bar : 40 mm

Soft steel bar : 20 mm

Cu strands : 40 mm

Al strands : 40 mm

ACSR : 40 mm

**Cutting of piano wire is prohibited.**

## ■ Features:

- Fast cutting with remote operation.
- Operated any hydraulic pump with rated oil pressure of 700 bar(10,000psi).
- Blades are easily replaceable.
- Flip-top latch for easy insertion of cutting material.

## ■ Accessories:

Carrying Bag



HYSC-45HE #15	Moving Blade
HYSC-45HE #10	Fixed Blade





## ■ Model No. **HYCC-35HE**

Length : 365 mm

Weight : 3.5 kgs

### ■ Specifications:

Max. Pressure : 700 bar

Oil Required : 67 cc

Max Output : 6.4 tons / 63 kN

Jaw Opening : 35 mm

### ■ Cutting Capacity:

Cu strands : 35 mm

Al strands : 35 mm

Cutting of piano wire is prohibited.

### ■ Features:

- C-framed open cutter for easy access to the cable.
- Fast cutting with remote operation.
- Operated by any hydraulic pump with rated oil pressure of 700 bar(10,000 psi).
- Blades are easily replaceable.
- Single action cylinder with spring return.

### ■ Accessories:

Carrying Bag



HYCC-35HE #3	Moving Blade
HYCC-35HE #2	Fixed Blade



# CUTTERS

## ■ Model No. **HYCC-050HE**

Length : 342 mm

Weight : 3.2 kgs

## ■ Specifications:

Max. Pressure : 700 bar

Oil Required : 38 cc

Max. Output : 5 tons / 49 kN

## ■ Cutting Capacity:

Cu strands : 50 mm

Al strands : 50 mm

CCP cable : 50 mm

**Cutting of piano wire is prohibited.**

## ■ Features:

- Fast cutting with remote operation.
- Operated any hydraulic pump with rated oil pressure of 700 bar(10,000psi).
- Blades are easily replaceable.
- Flip-top latch for easy insertion of cutting material.

## ■ Accessories:

Carrying Bag



HYCC-050HE #6	Moving Blade
HYSC-050HE #1	Fixed Blade



## ■ Model No. S-55HE

Length : 365 mm

Weight : 7.2 kgs

### ■ Specifications:

Max. Pressure : 700 bar

Oil Required : 107 cc

Max. Output : 12.7 tons / 125 kN

### ■ Cutting Capacity:

Wire rope 6x7 : 25 mm

Wire rope 6x12 : 30 mm

Wire rope 6x19 : 30 mm

Soft copper bar : 35 mm

Soft aluminum bar : 28 mm

Soft steel bar : 22 mm

Reinforcing rod : 19 mm

Cu strands : 54 mm

Al strands : 54 mm

ACSR : 54 mm

Guy wire 1x7 : 15 mm

Guy wire 1x19 : 20 mm

Underground cable : 50 mm

**Cutting of piano wire is prohibited.**

### ■ Features:

- Fast cutting with remote operation.
- Operated any hydraulic pump with rated oil pressure of 700bar (10,000 psi).
- Single action piston/cylinder arrangement.
- Blades are easily replaceable.
- Flip-top latch for easy insertion of cutting material.
- Single action cylinder with spring return.

### ■ Accessories:

Carrying Bag

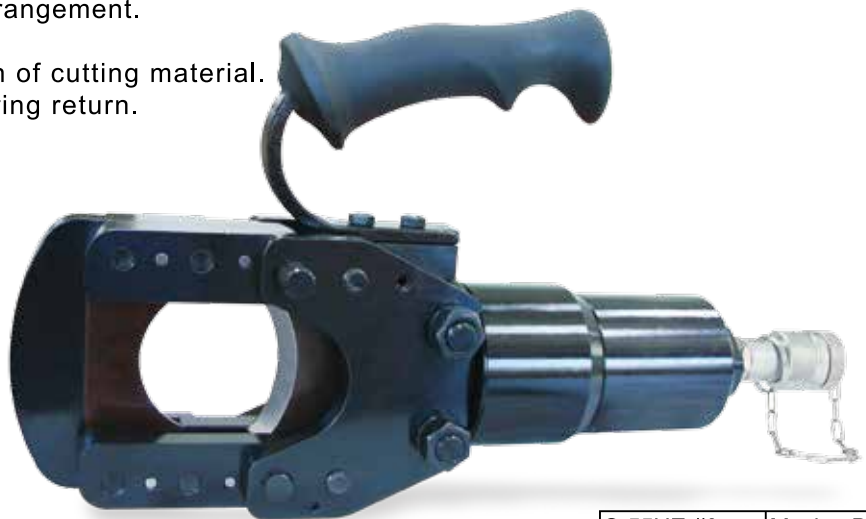

S-55HE #9	Moving Blade
S-55HE #26	Fixed Blade



# CUTTERS

## ■ Model No. **HYSC-55HE**

Length : 415 mm

Weight : 8.4 kgs

## ■ Specifications:

Max. Pressure : 700 bar

Oil Required : 107 cc

Max. Output : 14.9 tons / 146 kN

## ■ Cutting Capacity:

Wire rope 6x7 : 25 mm

Wire rope 6x12 : 30 mm

Wire rope 6x19 : 30 mm

Soft steel bar : 22 mm

Reinforcing rod : 19 mm

Cu strands : 50 mm

Al strands : 50 mm

ACSR : 50 mm

Guy wire 1x7 : 15 mm

Guy wire 1x19 : 20 mm

Soft copper bar : 24 mm

Soft aluminum bar : 18 mm

Underground cable : 24 mm

**Cutting of piano wire is prohibited.**

## ■ Features:

- Functional handle for convenient operation.
- Fast cutting with remote operation.
- Operated any hydraulic pump with rated oil pressure of 700 bar(10,000psi).
- Blades are easily replaceable.
- Flip-top latch for easy insertion of cutting material.
- Single stage pump action with spring return.

## ■ Accessories:

Carrying Bag



HYSC-55HE #2	Moving Blade
HYSC-55HE #14	Fixed Blade



## ■ Model No. **HYCC-P85HE**

Length : 430 mm

Weight : 6.8 kgs

### ■ Specifications:

Max. Pressure : 700 bar

Oil Required : 65 cc

Max. Output : 5 tons / 49 kN

### ■ Cutting Capacity:

Cu strands : 28 mm

Al strands : 38 mm

CCP cable : 85 mm

Underground cable : 50 mm (Except armoured cable)

**Cutting of piano wire is prohibited.**

### ■ Features:

- Functional handle for convenient operation.
- Lock pin type cutting head.
- Fast cutting with remote operation.
- Operated by any hydraulic pump with rated oil pressure of 700 bar(10,000 psi).
- Blades are easily replaceable.
- Single action cylinder with spring return.

### ■ Accessories:

Carrying Bag



HYCC-P85HE #10	Moving Blade
HYCC-P85HE #5	Fixed Blade



## ■ Model No. **TC-085HE**

Length : 373 mm

Weight : 4.9 kgs

## ■ Specifications:

Max. Pressure : 700 bar

Oil Required : 73 cc

Max. Output : 5.6 tons / 56 kN

## ■ Cutting Capacity:

Cu strands : 85 mm

Al strands : 85 mm

CCP cable : 85 mm

**Cutting of piano wire is prohibited.**

## ■ Features:

- Fast cutting with remote operation.
- Operated any hydraulic pump with rated oil pressure of 700 bar(10,000psi).
- Blades are easily replaceable.
- Flip-top latch for easy insertion of cutting material.
- Single action cylinder with spring return.

## ■ Accessories:

Carrying Bag



TC-085HE #4	Moving Blade
TC-085HE #3	Fixed Blade



## ■ Model No. **HYCC-P100HE**

Length : 544 mm

Weight : 12.7 kgs

### ■ Specifications:

Max. Pressure : 700 bar

Oil Required : 140 cc

Max. Output : 8.8 tons / 87 kN

### ■ Cutting Capacity:

Cu strands : 42 mm

Al strands : 46 mm

CCP cable : 100 mm

**Cutting of piano wire is prohibited.**

### ■ Features:

- Functional handle for convenient operation.
- Lock pin type cutting head.
- Fast cutting with remote operation.
- Operated by any hydraulic pump with rated oil pressure of 700 bar(10,000 psi).
- Blades are easily replaceable.
- Single action cylinder with spring return.

### ■ Accessories:

Carrying Bag



HYCC-P100HE #16	Moving Blade
HYCC-P100HE #17	Fixed Blade



# CUTTERS

## ■ Model No. **HYCC-105HE**

Length : 590 mm

Weight : 13.2 kgs

## ■ Specifications:

Max. Pressure : 700 bar

Oil Required : 178 cc

Max. Output : 10.2 tons / 100 kN

## ■ Cutting Capacity:

Cu strands : 42 mm

Al strands : 46 mm

CCP cable : 105 mm

**Cutting of piano wire is prohibited.**

## ■ Features:

- Functional handle for convenient operation.
- Lock pin type cutting head.
- Fast cutting with remote operation.
- Operated by any hydraulic pump with rated oil pressure of 700 bar(10,000 psi).
- Blades are easily replaceable.
- Single action cylinder with spring return.

## ■ Accessories:

Plastic Carrying Case



HYCC-105HE #2	Moving Blade
HYCC-105HE #1	Fixed Blade





## ■ Model No. **TC-120HE**

Length : 560 mm

Weight : 9.6 kgs

### ■ Specifications:

Max. Pressure : 700 bar

Oil Required : 193 cc

Max. Output : 10.6 tons / 105 kN

### ■ Cutting Capacity:

Cu cable : 120 mm

Al cable : 120 mm

CCP cable : 120 mm

**Cutting of piano wire is prohibited.**

### ■ Features:

- Functional handle for convenient operation.
- Lock pin type cutting head.
- Fast cutting with remote operation.
- Operated by any hydraulic pump with rated oil. pressure of 700 bar(10,000 psi).
- Blades are easily replaceable.
- Single action cylinder with spring return.



### ■ Accessories:

Carrying Bag



TC-120HE #17	Moving Blade
TC-120HE #26	Fixed Blade



## ■ Model No. **YS-30AHE**

Length : 277 mm

Weight : 3.0 kgs

## ■ Specifications:

Max. Pressure : 700 bar

Oil Required : 23 cc

Max. Output : 7.9 tons / 77.8 kN

## ■ Cutting Capacity:

Cu strands : 28 mm

Al strands : 28 mm

Telephone cable : 30 mm

Underground cable : 30 mm

ACSR : 19 mm

CCP cable : 30 mm

**Cutting of piano wire is prohibited.**

## ■ Features:

- Fast cutting with remote operation.
- Operated any hydraulic pump with rated oil pressure of 700 bar(10,000psi).

## ■ Accessories:

Carrying Bag



YS-30AHE #4	Moving Blade
YS-30AHE #5	Moving Blade



■ **Model No. HYCC-065HE**



Length : 419 mm  
Weight : 4.9 kg

■ **Specifications:**

Max. Pressure : 700 bar  
Oil Required : 36 cc  
Max. Output : 7.5 tons / 73.5 kN

■ **Cutting Capacity:**

Cu cable : 60 mm  
Al cable : 60 mm  
CCP cable : 65 mm  
Underground cable : 65 mm (Except armoured cable)  
**Cutting of piano wire is prohibited.**

■ **Features:**

- Fast cutting with remote operation.
- Operated any hydraulic pump with rated oil pressure of 700 bar(10,000psi).

■ **Accessories:**

Carrying Bag



P-85YC #6	Moving Blade
P-85YC #7	Moving Blade



# CUTTERS

## ■ Model No. **HYCC-075S**

Length : 373 mm

Weight : 9.0 kg



## ■ Specifications:

Max. Pressure : 700 bar

Oil Required : 215 cc

Max. Output : 20 tons / 196 kN

## ■ Cutting Capacity:

Cu cable : 75 mm

Al cable : 75 mm

Underground cable : max. up to 240 mm<sup>2</sup> x 4 cores  
approx. 65 mm outer diameter

**Cutting of piano wire is prohibited.**

## ■ Features:

- Fast cutting with remote operation.
- Operated any hydraulic pump with rated oil pressure of 700 bar(10,000psi).

## ■ Accessories:

Carrying Bag



HYCC-075S #21	Moving Blade
HYCC-075S #22	Moving Blade



## ■ Model No. **HYCC-096S**

Length : 394 mm

Weight : 8.1 kgs

### ■ Specifications:

Max. Pressure : 700 bar

Oil Required : 172 cc

Max. Output : 13.5 tons / 132.3 kN

### ■ Cutting Capacity:

Cu cable : 95 mm

Al cable : 95 mm

Cutting of piano wire is prohibited.

### ■ Features:

- Fast cutting with remote operation.
- Operated any hydraulic pump with rated oil pressure of 700 bar(10,000psi).

### ■ Accessories:

Carrying Bag



HYCC-096S #3	Moving Blade
HYCC-096S #3	Moving Blade



## ■ Model No. P-85YC

Length : 395 mm

Weight : 5.0 kgs

## ■ Specifications:

Max. Pressure : 700 bar

Oil Required : 48 cc

Max. Output : 7.5 tons / 73.5 kN

## ■ Cutting Capacity:

Cu cable : 60 mm

Al cable : 60 mm

CCP cable : 85 mm

Underground cable : 85 mm (Except armoured cable)

**Cutting of piano wire is prohibited.**

## ■ Features:

- Fast cutting with remote operation.
- Operated any hydraulic pump with rated oil pressure of 700 bar(10,000psi).

## ■ Accessories:

Carrying Bag



P-85YC #6	Moving Blade
P-85YC #7	Moving Blade



## ■ Compression Capacity Chart

Model No. Compression Tools	Output (tons)	Ram Stroke (mm)	Weight (kg)	Applicable Compression Range		
				Steel Lugs / Conductors	Copper Lugs / Conductors	Aluminum Lugs / Conductors
HH-400	14.3	27.8	5.8	Tool only		
HH-400I	14.3	27.8	5.8		8-325 mm <sup>2</sup>	
HH-400X	14.3	27.8	5.8		22-325 mm <sup>2</sup>	
HH-400XL	14.3	27.8	5.8		120-400 mm <sup>2</sup>	
9H-150	12.7	17.0	5.0		14-150 mm <sup>2</sup>	
HYCP-185	5.3	16.7	2.1	(Accepts BEKU type dies)	185 mm <sup>2</sup>	150 mm <sup>2</sup>
HYCP-240	5.3	13.5	2.4		240 mm <sup>2</sup>	185 mm <sup>2</sup>
PH-240	6.2	16.0	3.2	(Accepts all dies used for Alcoa, Burndy, T&B, Klauke, Cembre and Blackburn 6 tons compressor)	240 mm <sup>2</sup>	185 mm <sup>2</sup>
UCP-240	8.8	20.1	4.6	(Accepts BEKU type dies)	240 mm <sup>2</sup>	185 mm <sup>2</sup>
UCP-2613	12.7	26.0	5.3	(Accepts all dies used for Alcoa, Burndy, T&B, Klauke, Cembre and Blackburn 12 tons compressor)	Up to 400 mm <sup>2</sup>	Up to 300 mm <sup>2</sup>
UB-400	12.7	26.0	6.7		Up to 400 mm <sup>2</sup>	Up to 300 mm <sup>2</sup>
UB-400C	12.7	26.0	6.7		Up to 400 mm <sup>2</sup>	Up to 300 mm <sup>2</sup>
UCP-2712	12.7	27.0	6.2		Up to 400 mm <sup>2</sup>	Up to 300 mm <sup>2</sup>
UC-6FT	6.4	32.0	5.8		Anderson type connectors up to 750 MCM	
UB-412	11.6	32.0	6.5	(Accepts all dies used for Alcoa, Burndy, T&B, Klauke, Cembre and Blackburn 12 tons compressor)	Up to 400 mm <sup>2</sup>	Up to 300 mm <sup>2</sup>
UB-412C	11.6	32.0	6.5		Up to 400 mm <sup>2</sup>	Up to 300 mm <sup>2</sup>
HYCP-4413	12.7	44.0	7.6		Up to 400 mm <sup>2</sup>	Up to 300 mm <sup>2</sup>
HYCP-4413C	12.7	44.0	7.6		Up to 400 mm <sup>2</sup>	Up to 300 mm <sup>2</sup>
UC-6	6.4	29.8	5.8	Anderson type connectors up to 500 MCM		
UC-6C	6.4	29.8	5.8	Anderson type connectors up to 500 MCM		

# CRIMPERS

## ■ Model No. HH-400

Length: 559 mm

Weight: 5.8 kgs

## ■ Specifications:

Max. Pressure : 700 bar

Oil Required : 57 cc

Max. Output : 14.3 tons / 140 kN

## ■ Features:

- Light weight, compact and slim design.
- Single stage pumping for rapid ram advance.
- Relief valve.
- Head rotates through 180° degree for difficult working environment.

## ■ Accessories:

Plastic carrying case

- Crimping tope only without any die set.
- Dies sold separately



### ■ Model No. HH-400I

- For solderless terminal 8~325 mm<sup>2</sup>
- With Support Die 8~22, 38, 60~80, 100, 150~180, 200 and 325 mm<sup>2</sup>
- With Indent Die 8~38, 60~100 and 150~325 mm<sup>2</sup> Dies

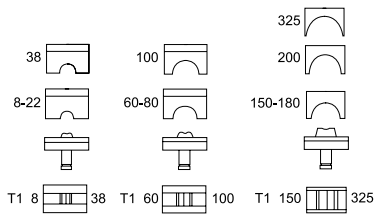

### ■ Model No. HH-400X

- With 8 of hexagonal die set for solderless terminal 22~325 mm<sup>2</sup>
- Die set : 22, 38, 60-70, 80, 100, 150-180, 200, 325

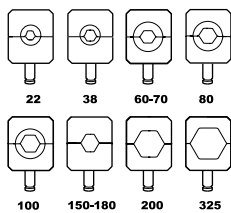

### ■ Model No. HH-400XL

- With 6 of hexagonal die set for cable lug 120 to 400 mm<sup>2</sup>
- Die set : LUG120, LUG150, LUG185, LUG240, LUG300, LUG400

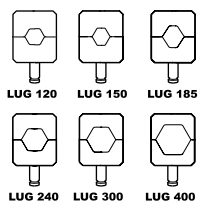

※ Crimping without die sets is prohibited.





## ■ Model No. 9H-150

Length : 528 mm

Weight : 5.0 kgs

## ■ Specifications:

Max. Pressure : 700 bar

Oil Required : 31 cc

Max. Output : 12.7 tons / 125 kN

## ■ Crimping Capacity:

- For non-Insulated terminals and sleeves up to 150 mm<sup>2</sup>
- With Indentor 14, 22, 38~70 and 80~150 mm<sup>2</sup>

## ■ Features:

- Light weight, compact and slim design.
- Rotary nest for easy setting.
- Two stage pumping for rapid ram advance.
- Relief valve.

## ■ Accessories:

Plastic carrying case

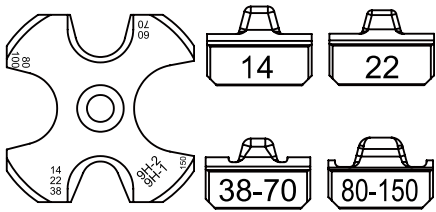

# CRIMPERS

## ■ Model No. **HYCP-185**

Length : 373 mm

Weight : 2.1 kgs

## ■ Specifications:

Max. Pressure : 550 bar

Oil Required : 16 cc

Max. Output : 5.3 tons / 52 kN

## ■ Crimping Capacity:

- Accepts BEKU type dies
- Stock Dies are for DIN46235 Terminals
- Dies sold separately (See page 151)  
(AHE 1016/2535/5070/95120/150/185)

## ■ Features:

- Light weight, compact and slim design.
- Single action cylinder with spring return.
- Accepts BEKU type dies .
- Yoke and Latch type head for easy die changes and removal of connectors.
- Adjustable ram stroke, 10-15 mm to minimize pumping action.
- Built-In bypass relief valve.
- Small handle spread for close quarter applications.

## ■ Accessories:

Plastic carrying case



※ Crimping without die sets is prohibited.



## ■ Model No. **HYCP-240**

Length : 377 mm

Weight : 2.4 kgs

### ■ Specifications:

Max. Pressure : 550 bar

Oil Required : 23 cc

Max. Output : 5.3 tons / 52 kN

### ■ Crimping Capacity:

- Accepts BEKU type dies
- Stock Dies are for DIN 46235 Terminals
- Dies sold separately (See page 151)  
(AHE1016/2535/5070/95120/150/185/240)

### ■ Features:

- Light weight, compact and slim design.
- Single action cylinder with spring return.
- Accepts BEKU type dies.
- Yoke and Latch type head for easy die changes and removal of connectors.
- Adjustable ram stroke, 10-15 mm to minimize pumping action.
- Built-In bypass relief valve.
- Small handle spread for close quarter applications.

### ■ Accessories:

Plastic carrying case



※ Crimping without die sets is prohibited.



## ■ Model No. PH-240

Length : 427 mm

Weight : 3.2 kgs

## ■ Specifications:

Max. Pressure : 550 bar

Oil Required : 18 cc

Max. Output : 6.2 tons / 61 kN

Ram Stroke : 14.8 mm

## ■ Crimping Capacity:

- Max. Compression : 240 mm<sup>2</sup> Aluminum lugs
- Accepts all dies used for Alcoa, Burndy, T&B, Klauke, Cembre and Blackburn 6 tons compressors
- Dies sold separately (See page 152)  
(T16/25/35/50/70/95/120/150/185/240)

## ■ Features:

- Light weight, compact and slim design.
- Pressure relief valve for overload protection.
- Automatic low/high-pressure conversion with rapid/slow operating motion.
- 180° rotating head for convenient operation.
- Two-stage hydraulic system reduces the number of pumps required.

## ■ Accessories:

Plastic carrying case



※ Crimping without die sets is prohibited.



## ■ Model No. **UCP-240**

Length : 630 mm

Weight : 4.6 kgs

## ■ Specifications:

Max. Pressure : 700 bar

Oil Required : 42 cc

Max. Output : 8.8 tons / 86 kN

Ram Stroke : 20.1 mm

## ■ Crimping Capacity:

- Accepts BEKU type dies
- Hex. Crimping : 10-240 mm<sup>2</sup>  
Cu sleeves & lugs NFC 20.130 : 10 to 240 mm<sup>2</sup>  
Cu or Al bare or insulated sleeve : E54 to E230  
Cu or Al sleeves & lugs DIN 48083 : KZ6 to KZ25  
Pre-rounding : 35 to 240mm<sup>2</sup>
- Dies sold separately (See page 155)

## ■ Features:

- Light weight, compact and slim design.
- 180° rotating head for convenient operation.
- Pressure relief valve for overload protection.
- Automatic low/high-pressure conversion with rapid/slow operating motion.
- Two-stage hydraulic system reduces the number of pumps required.
- Small handle spread for close quarter applications.

## ■ Accessories:

Plastic carrying case



※ Crimping without die sets is prohibited.



# CRIMPERS

## ■ Model No. **UCP-2613**

Height : 600 mm  
Weight : 5.3 kgs



### ■ Specifications:

Max. Pressure : 700 bar  
Oil Required : 48 cc  
Max Output : 12.7 tons / 125 kN  
Jaw Opening : 26 mm

### ■ Crimping Capacity:

- U-Type Head
- Crimping force : 12.7 tons / 125 kN

#### ■ Main Applications :

Cu conductors : 400 mm<sup>2</sup>  
Al conductors : 300 mm<sup>2</sup>  
C sleeves connector : 120 mm<sup>2</sup>

### ■ Features:

- Fiberglass handles are durable and light weight.
- Pressure relief valve for overload protection.
- Automatic low / high-pressure conversion with rapid / slow operating motion.
- 350° rotating head for convenient operation.
- External adjustable relief valve.
- Two-stage hydraulic system reduces the number of pumps required.

### ■ Accessories:

Plastic carrying case



## ■ Model No. **UB-400**

Height : 598 mm  
Weight : 6.8 kgs

## ■ Specifications:

Max. Pressure : 700 bar  
Oil Required : 48 cc  
Max Output : 12.7 tons / 125 kN  
Jaw Opening : 26 mm

## ■ Crimping Capacity:

- Max. Compression : 400 mm<sup>2</sup> copper / aluminum lugs.
- Accepts all dies used for Alcoa, Burndy, T&B, Klauke, Cembre and Blackburn 12-tons compressors.
- Dies sold separately (See page 151)  
(CU 16/25/35/50/70/95/120/150/185/240/300/400)

## ■ Features:

- 330° rotating head for convenient operation.
- Fiberglass handles are durable and light weight.
- External adjustable relief valve.
- Pressure relief valve for overload protection.
- Automatic low / high-pressure conversion with rapid / slow operating motion.
- Two-stage hydraulic system reduces the number of pumps required.

## ■ Accessories:

Plastic carrying case



※ Crimping without die sets is prohibited.



# CRIMPERS

## ■ Model No. **UB-400C**

Height : 598 mm

Weight : 6.8 kgs

## ■ Specifications:

Max. Pressure : 700 bar

Oil Required : 48 cc

Max Output : 12.7 tons / 125 kN

Jaw Opening : 26 mm

## ■ Crimping Capacity:

- Max. Compression : 400 mm<sup>2</sup> copper / aluminum lugs.
- Accepts all dies used for Alcoa, Burndy, T&B, Klauke, Cembre and Blackburn 12-tons compressors.
- Dies sold separately (See page 151)  
(CU 16/25/35/50/70/95/120/150/185/240/300/400)

## ■ Features:

- 330° rotating head for convenient operation.
- Fiberglass handles are durable and light weight.
- External adjustable relief valve.
- Pressure relief valve for overload protection.
- Automatic low / high-pressure conversion with rapid / slow operating motion.
- Two-stage hydraulic system reduces the number of pumps required.

## ■ Accessories:

Plastic carrying case



- Insulated cap should be ordered separately.

※ Crimping without die sets is prohibited.





## ■ Model No. **UCP-2712**

Length : 590 mm

Weight : 6.2 kgs

### ■ Specifications:

Max. Pressure : 700 bar / 10,000 psi

Oil Required : 50 cc

Max. Output : 12.7 tons / 125 kN

### ■ Crimping Capacity:

- Max. Compression : 400 mm<sup>2</sup> copper lugs
- Accepts all dies used for Alcoa, Burndy, T&B, Klauke, Cembre and Blackburn 12-ton compressors
- Dies sold separately (See page 151)  
(CU 16/25/35/50/70/95/120/150/185/240/300/400)

### ■ Features:

- 180° rotating head for convenient operation.
- Fiberglass handles are durable and light weight.
- External adjustable relief valve.
- Pressure relief valve for overload protection.
- Automatic low/high-pressure conversion with rapid/slow operating motion.
- Two-stage hydraulic system reduces the number of pumps required.

### ■ Accessories:

Plastic carrying case



※ Crimping without die sets is prohibited.



# CRIMPERS

## ■ Model No. UC-6FT

Length : 580 mm

Weight : 5.8 kgs

## ■ Specifications:

Max. Pressure	: 700 bar
Oil Required	: 27 cc
Max. Output	: 6.4 tons / 62 kN
Jaw Opening	: 38 mm
Max. Crimping Capacity	: up to 36mm outer diameter connector (UC-6FT)

## ■ Features:

- Light weight, compact and slim design.
- Pressure relief valve for overload protection.
- Automatic low/high-pressure conversion with rapid/slow operating motion.
- 360° rotating head for convenient operation.
- Two-stage hydraulic system reduces the number of pumps required.
- Dieless compression to crimp Anderson style connectors up to 750 MCM.

## ■ Accessories:

Plastic carrying case

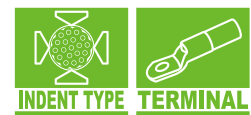

## ■ Model No. **UB-412**

Length : 612 mm

Weight : 6.5 kgs

### ■ Specifications:

Max. Pressure : 700 bar

Oil Required : 53 cc

Max. Output : 11.6 tons / 114 kN

Jaw Opening : 32 mm

### ■ Crimping Capacity:

- Max. Compression : 400 mm<sup>2</sup> copper lugs
- Accepts all dies used for Alcoa, Burndy, T&B, Klauke, Cembre and Blackburn 12-ton compressors
- Dies sold separately (See page 151)  
(CU 16/25/35/50/70/95/120/150/185/240/300/400)

### ■ Features:

- 180° rotating head for convenient operation.
- Fiberglass handles are durable and light weight.
- External adjustable relief valve.
- Pressure relief valve for overload protection.
- Automatic low/high-pressure conversion with rapid/slow operating motion.
- Two-stage hydraulic system reduces the number of pumps required.

### ■ Accessories:

Plastic carrying case



※ Crimping without die sets is prohibited.



# CRIMPERS

## ■ Model No. **UB-412C**

Length : 612 mm

Weight : 6.5 kgs

## ■ Specifications:

Max. Pressure : 700 bar

Oil Required : 53 cc

Max. Output : 11.6 tons / 114 kN

Jaw Opening : 32 mm

## ■ Crimping Capacity:

- Max. Compression : 400 mm<sup>2</sup> copper lugs
- Accepts all dies used for Alcoa, Burndy, T&B, Klauke, Cembre and Blackburn 12-ton compressors
- Dies sold separately (See page 151)  
(CU 16/25/35/50/70/95/120/150/185/240/300/400)

## ■ Features:

- 180° rotating head for convenient operation.
- Fiberglass handles are durable and light weight.
- External adjustable relief valve.
- Pressure relief valve for overload protection.
- Automatic low/high-pressure conversion with rapid/slow operating motion.
- Two-stage hydraulic system reduces the number of pumps required.

## ■ Accessories:

Plastic carrying case



- Insulated cap should be ordered separately.

※ Crimping without die sets is prohibited.



## ■ Model No. **HYCP-4413**

Length : 641 mm

Weight : 7.6 kgs

## ■ Specifications:

Max. Pressure : 700 bar

Oil Required : 80 cc

Max. Output : 12.7 tons / 125 kN

Jaw Opening : 44 mm

## ■ Crimping Capacity:

- Max. Compression : 400 mm<sup>2</sup> copper lugs
- Accepts all dies used for Alcoa, Burndy, T&B, Klauke, Cembre and Blackburn 12-ton compressors
- Dies sold separately (See page 151)  
(CU 16/25/35/50/70/95/120/150/185/240/300/400)

## ■ Features:

- Fiberglass handles are durable and light weight.
- Pressure relief valve for overload protection.
- Automatic low/high-pressure conversion with rapid/slow operating motion.
- 180° rotating head for convenient operation.
- External adjustable relief valve.
- Two-stage hydraulic system reduces the number of pumps required.

## ■ Accessories:

Plastic carrying case



※ Crimping without die sets is prohibited.



# CRIMPERS

## ■ Model No. **HYCP-4413C**

Length : 641 mm

Weight : 7.6 kgs

## ■ Specifications:

Max. Pressure : 700 bar

Oil Required : 80 cc

Max. Output : 12.7 tons / 125 kN

Jaw Opening : 44 mm

## ■ Crimping Capacity:

- Max. Compression : 400 mm<sup>2</sup> copper lugs
- Accepts all dies used for Alcoa, Burndy, T&B, Klauke, Cembre and Blackburn 12-ton compressors
- Dies sold separately (See page 151)  
(CU 16/25/35/50/70/95/120/150/185/240/300/400)

## ■ Features:

- Fiberglass handles are durable and light weight.
- Pressure relief valve for overload protection.
- Automatic low/high-pressure conversion with rapid/slow operating motion.
- 180° rotating head for convenient operation.
- External adjustable relief valve.
- Two-stage hydraulic system reduces the number of pumps required.

## ■ Accessories:

Plastic carrying case



- Insulated cap should be ordered separately.

※ Crimping without die sets is prohibited.



## ■ Model No. **UC-6**



Length : 627 mm  
Weight : 6.2 kgs

### ■ Specifications:

Max.	Pressure : 700 bar
Oil	Required : 27 cc
Max.	Output : 6.4 tons / 62 kN
Jaw	Opening : 35.8 mm
Max. Crimping Capacity : up to 32mm outer diameter connector (UC-6)	

### ■ Features:

- Light weight, compact and slim design.
- Pressure relief valve for overload protection.
- Automatic low/high-pressure conversion with rapid/slow operating motion.
- 360° rotating head for convenient operation.
- Two-stage hydraulic system reduces the number of pumps required.
- Dieless compression to crimp Anderson style connectors up to 500 MCM.

### ■ Accessories:

Plastic carrying case

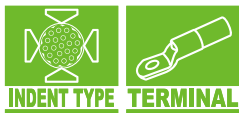

# CRIMPERS

## ■ Model No. **UC-6C**



Length : 627 mm  
Weight : 6.2 kgs

### ■ Specifications:

Max. Pressure : 700 bar  
Oil Required : 27 cc  
Max. Output : 6.4 tons / 62 kN  
Jaw Opening : 35.8 mm  
Max. Crimping Capacity : up to 32mm outer diameter connector (UC-6)

### ■ Features:

- Light weight, compact and slim design.
- Pressure relief valve for overload protection.
- Automatic low/high-pressure conversion with rapid/slow operating motion.
- 360° rotating head for convenient operation.
- Two-stage hydraulic system reduces the number of pumps required.
- Dieless compression to crimp Anderson style connectors up to 500 MCM.

### ■ Accessories:

Plastic carrying case



- Insulated cap should be ordered separately.

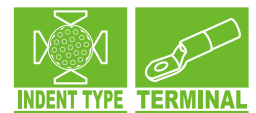



## ■ Compression Capacity Chart

Model No. Compression Tools	Output (tons)	Ram Stroke (mm)	Action	Weight (kg)	Applicable Compression Range		
					Steel Lugs / Conductors	Copper Lugs / Conductors	Aluminum Lugs / Conductors
HH-400HE	14.3	27.8	Single	3.7	(Accepts all dies used for Alcoa, Burndy, T&B, Klauke, Cembre and Blackburn 6 ton compressor)	Up to 400 mm <sup>2</sup>	Up to 300 mm <sup>2</sup>
9H-150HE	12.7	17.0	Single	2.6	150 mm <sup>2</sup>	150 mm <sup>2</sup>	120 mm <sup>2</sup>
HYCP-185HE	5.3	17.3	Single	1.8	(Accepts BEKU type dies)	185 mm <sup>2</sup>	150 mm <sup>2</sup>
HYCP-240HE	5.3	13.5	Single	2.1		240 mm <sup>2</sup>	185 mm <sup>2</sup>
PH-240HE	6.4	19.3	Single	2.6	(Accepts all dies used for Alcoa, Burndy, T&B, Klauke, Cembre and Blackburn 6 ton compressor)	240 mm <sup>2</sup>	185 mm <sup>2</sup>
UCP-240HE	8.8	16.5	Single	2.7	(Accepts BEKU type dies)	240 mm <sup>2</sup>	185 mm <sup>2</sup>
UB-400HE	12.7	26.0	Single	4.6	(Accepts all dies used for Alcoa, Burndy, T&B, Klauke, Cembre and Blackburn 12 ton compressor)	Up to 400 mm <sup>2</sup>	Up to 300 mm <sup>2</sup>
UCP-2712HE	12.7	27.0	Single	4.0		Up to 400 mm <sup>2</sup>	Up to 300 mm <sup>2</sup>
UB-412HE	11.6	32.0	Single	4.9		Up to 400 mm <sup>2</sup>	Up to 300 mm <sup>2</sup>
HYCP-4413HE	12.7	44.0	Single	5.1		Up to 400 mm <sup>2</sup>	Up to 300 mm <sup>2</sup>
UC-6FTHE	6.4	32.0	Single	3.2		(Dieless compressor)	Anderson type connectors up to 750 MCM
UC-6HE	6.4	29.8	Single	3.2	Anderson type connectors up to 500 MCM		
HYCP-15HE	14.1	50.6	Single	6.9	(U-type dies can be used with adaptor die seats)	Up to 400 mm <sup>2</sup>	Up to 400 mm <sup>2</sup>
HYCP-630HE	22.5	27.5	Single	5.6		Up to 400 mm <sup>2</sup>	Up to 400 mm <sup>2</sup>
HYCP-451000HE	44.5	35.5	Single	11.6		16-1000 mm <sup>2</sup>	
HYCP-500HE	31.0	30.0	Single	17.1	(Suitable for JIS C2804 terminals)	8-500 mm <sup>2</sup>	30-590 mm <sup>2</sup>
HYCP-60ST	55.0	38.7	Single	21.3	Up to Ø 60 mm O.D. Sleeves		
HYCP-60D	55.0	38.0	Single	23.3			
UA-100STS	100.0	29.5	Single	36.0	Up to Ø 32 mm O.D. Sleeves	Up to Ø 64 mm O.D. Sleeves	Up to Ø 71 mm O.D. Sleeves
UA-100ST	100.0	29.5	Double	37.6			
SR-100C	100.0	22.0	Double	31.4			
100W	100.0	26.9	Double	33.8			
200W	200.0	37.0	Double	74.0	Up to Ø 50 mm O.D. Sleeves	Up to Ø 86 mm O.D. Sleeves	Up to Ø 100 mm O.D. Sleeves

# COMPRESSION HEAD

## ■ Model No. **HH-400HE**

Length : 277 mm

Weight : 3.7 kgs

## ■ Specifications:

Max. Pressure : 700 bar

Oil Required : 57 cc

Max. Output : 14.3 tons / 140 kN

## ■ Features:

- Yoke-type head design is solid and durable.
- Positive die locking mechanism holds dies firmly in place.
- Operated by are hydrable pump with rated oil pressure of 700 bar (10,000 psi).
- Dies sold separately (See page 111)

## ■ Accessories:

Plastic carrying case

- Dies sold separately (See page 111)



## ■ Model No. 9H-150HE

Length : 246 mm

Weight : 2.6 kgs

## ■ Specifications:

Max. Pressure : 700 bar

Oil Required : 31 cc

Max. Output : 12.7 tons / 125 kN

## ■ Crimping Capacity:

- For non-Insulated terminals and sleeves up to 150mm<sup>2</sup>
- With Indentors 14, 22, 38~70 and 80~150mm<sup>2</sup>

## ■ Features:

- Light weight, compact and slim design.
- Rotary nest for easy setting.
- Operated any hydraulic pump with rated oil pressure of 700 bar(10,000psi).

## ■ Accessories:

Plastic carrying case

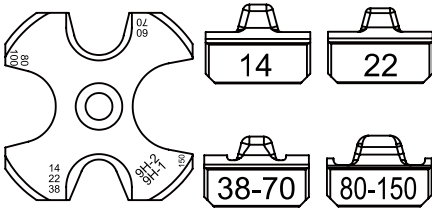

# COMPRESSION HEAD

## ■ Model No. **HYCP-185HE**

Length : 264 mm

Weight : 1.8 kgs

## ■ Specifications:

Max. Pressure : 700 bar

Oil Required : 13 cc

Max. Output : 5.3 tons / 52 kN

## ■ Crimping Capacity:

- Accepts BEKU type dies
- Stock Dies are for DIN 46235 Terminals
- Dies sold separately (See page 151)  
(AHE 1016/2535/5070/95120/150/185)

## ■ Accessories:

Plastic carrying case



## ■ Model No. **HYCP-240HE**

Length : 263 mm

Weight : 2.1 kgs

## ■ Specifications:

Max. Pressure : 700 bar

Oil Required : 13 cc

Max. Output : 5.3 tons / 52 kN

## ■ Crimping Capacity:

- Accepts BEKU type dies
- Stock Dies are for DIN 46235 Terminals
- Dies sold separately (See page 151)  
(AHE1016/2535/5070/95120/150/185/240)

## ■ Accessories:

Plastic carrying case



## ■ Model No. **PH-240HE**

Length : 209 mm

Weight : 2.7 kgs

## ■ Specifications:

Max. Pressure : 700 bar

Oil Required : 14 cc

Max. Output : 6.4 tons / 65 kN

## ■ Crimping Capacity:

- Max. Compression : 240 mm<sup>2</sup> Aluminum , lugs
- Accepts all dies used for Alcoa, Burndy, T&B, Klauke, Cembre and Blackburn 6 ton compressors
- Dies sold separately (See page 152)  
(T16/25/35/50/70/95/120/150/185/240)

## ■ Features:

- Light weight, compact and slim design.
- Operated any hydraulic pump with rated oil pressure of 700 bar(10,000psi).

## ■ Accessories:

Plastic carrying case



※ Crimping without die sets is prohibited.



## ■ Model No. **UCP-240HE**

Height : 213 mm

Weight : 2.6 kgs

## ■ Specifications:

Max. Pressure : 700 bar

Oil Required : 24 cc

Max. Output : 8.8 tons / 86 kN

## ■ Crimping Capacity:

- Accepts BEKU type dies
- Hex. Crimping : 10-240 mm<sup>2</sup>  
Cu sleeves & lugs NFC 20.130 : 10 to 240 mm  
Cu or Al bare or insulated sleeve : E54 to E230  
Cu or Al sleeves & lugs DIN 48083 : KZ6 to KZ25  
Pre - rounding : 35 to 240 mm
- Dies sold separately (See page 155)

## ■ Features:

- Light weight, compact and slim design.
- Operated any hydraulic pump with rated oil pressure of 700 bar(10,000psi).

## ■ Accessories:

Plastic carrying case



## ■ Model No. **UB-400HE**

Length : 260 mm

Weight : 4.6 kgs

## ■ Specifications:

Max. Pressure : 700 bar

Oil Required : 47 cc

Max. Output : 12.7 tons / 125 kN

Jaw Opening : 26 mm

## ■ Crimping Capacity:

- Max. Compression : 400 mm<sup>2</sup> copper lugs
- Accepts all dies used for Alcoa, Burndy, T&B, Klauke, Cembre and Blackburn 12-ton compressors
- Dies sold separately (See page 151)  
(CU 16/25/35/50/70/95/120/150/185/240/300/400)

## ■ Features:

- C-frame has open jaw for easy access to the fitting.
- Operated by air hydrurable pump with rated oil pressure of 700 bar (10,000 psi).
- Single action cylinder with spring return.
- Dies are easy to change.
- Crimping capacity identical to UB-400 tool.  
(See page 118 \ 119)

## ■ Accessories:

Plastic carrying case



※ Crimping without die sets is prohibited.





## ■ Model No. **UCP-2712HE**

Length : 247 mm

Weight : 4.0 kgs

## ■ Specifications:

Max. Pressure : 700 bar / 10,000 psi

Oil Required : 49 cc

Max. Output : 12.7 tons / 125 kN

## ■ Crimping Capacity:

- Max. Compression : 400 mm<sup>2</sup> copper lugs
- Accepts all dies used for Alcoa, Burndy, T&B, Klauke, Cembre and Blackburn 12-ton compressors
- Dies sold separately (See page 151)  
(CU 16/25/35/50/70/95/120/150/185/240/300/400)

## ■ Features:

- Operated by any 700 bar / 10,000psi rated pump.
- Single action cylinder with spring return.
- Lock pin design holds die firmly in place.
- Die sizes available : CU16~CU400mm<sup>2</sup>
- Custom die sets are manufactured on request.

## ■ Accessories:

Plastic carrying case



※ Crimping without die sets is prohibited.



## ■ Model No. UB-412HE

Length : 258 mm  
Weight : 4.2 kgs

### ■ Specifications:

Max. Pressure : 700 bar  
Oil Required : 53 cc  
Max. Output : 11.6 tons / 114 kN  
Jaw Opening : 32mm

### ■ Crimping Capacity:

- Max. Compression : 400mm<sup>2</sup> copper lugs
- Accepts all dies used for Alcoa, Burndy, T&B, Klauke, Cembre and Blackburn 12-ton compressors
- Dies sold separately (See page 151)  
(CU16/25/35/50/70/95/120/150/185/240/300/400)

### ■ Features:

- C-frame has open jaw for easy access to the fitting.
- Operated by any hydraulic pump with rated oil pressure of 700 bar (10,000 psi).
- Single action cylinder with spring return.
- Dies are easy to change.
- Crimping capacity identical to UB-412 tool. (See page 122 - 123)

### ■ Accessories:

Plastic carrying case



## ■ Model No. H-412HE

Length : 335 mm  
Weight : 4.3 kgs

### ■ Specifications:

Max. Pressure : 700 bar  
Oil Required : 53 cc  
Max. Output : 11.6 tons / 114 kN  
Jaw Opening : 32mm

### ■ Crimping Capacity:

- Max. Compression : 400mm<sup>2</sup> copper lugs
- Accepts all dies used for Alcoa, Burndy, T&B, Klauke, Cembre and Blackburn 12-ton compressors
- Dies sold separately (See page 151)  
(CU16/25/35/50/70/95/120/150/185/240/300/400)

### ■ Features:

- C-frame has open jaw for easy access to the fitting.
- Operated by any hydraulic pump with rated oil pressure of 700 bar (10,000 psi).
- Single action cylinder with spring return.
- Handle grip for easy carrying.
- Crimping capacity identical to UB-412 tool. (See page 122 - 123)
- Dies are easy to change.

### ■ Accessories:

Plastic carrying case



※ Crimping without die sets is prohibited.



■ **Model No. HYCP-4413HE**

Length : 276 mm

Weight : 5.1 kgs

■ **Specifications:**

Max. Pressure : 700 bar

Oil Required : 80 cc

Max Output : 12.7 tons / 125 kN

Jaw Opening : 44 mm

■ **Crimping Capacity:**

- Dies sold separately (See page 151)  
(CU 16/25/35/50/70/95/120/150/185/240/300/400)

■ **Features:**

- Accepts all U type dies used for 12 ton compression tools.

■ **Accessories:**

Plastic carrying case



※ Crimping without die sets is prohibited.



# COMPRESSION HEAD

## ■ Model No. **UC-6FTHE**

Length : 296 mm

Weight : 3.4 kgs

### ■ Specifications:

Max. Pressure : 700 bar  
Oil Required : 29 cc  
Max. Output : 6.4 tons / 62 kN  
Max. Crimping Capacity : up to 36mm outer diameter connector (UC-6FT)

### ■ Features:

- Light weight, compact and slim design.
- Operated by any hydraulic pump with rated oil pressure of 700 bar(10,000psi).
- Dieless compression to crimp Anderson style connectors up to 750 MCM.

### ■ Accessories:

Plastic carrying case

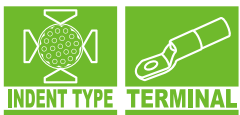

## ■ Model No. **UC-6HE**

Length : 278 mm

Weight : 3.2 kgs

### ■ Specifications:

Max. Pressure : 700 bar  
Oil Required : 27 cc  
Max. Output : 6.4 tons / 62 kN  
Max. Crimping Capacity : up to 32mm outer diameter connector (UC-6)

### ■ Features:

- Light weight, compact and slim design.
- Operated by any hydraulic pump with rated oil pressure of 700 bar(10,000psi).
- Dieless compression to crimp Anderson style connectors up to 500 MCM.

### ■ Accessories:

Plastic carrying case

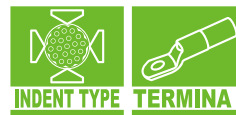

## ■ Model No. HYCP-15THE

Length : 375 mm

Weight : 6.9 kgs

### ■ Specifications:

Max. Pressure : 700 bar

Oil Required : 104 cc

Max. Output : 14.1 tons / 138 kN

Jaw Opening : 50.6 mm

(45mm with die adapter ADP-15THE)

### ■ Crimping Capacity:

- Compatible with BURNDY P dies
- Compatible with all dies used for Alcoa, Burndy, T&B, Klauke, Cembre and Blackburn 12-ton compressors when used with Adapter (ADP-15THE)
- Dies sold separately (See page 155)  
(CU 16/25/35/50/70/95/120/150/185/240/300/400)

### ■ Features:

- C-frame has open jaw for easy access to the fitting.
- Operated by any hydraulic pump with rated oil pressure of 700 bar (10,000 psi).
- Single action cylinder with spring return.
- Dies are easy to change.

### ■ Accessories:

Plastic carrying case (See page 219)



## ■ Model No. ADP-15THE

This adapter is designed for hydraulic compression head HYCP-15THE to interchange with die sets from other 12-ton tools (up to 400 mm<sup>2</sup>)



※ Crimping without die sets is prohibited.



# COMPRESSION HEAD

## ■ Model No. **HYCP-630HE**

Height : 320 mm

Weight : 5.6 kgs

## ■ Specifications:

Max. Pressure : 700 bar

Oil Required : 89 cc

Max. Output : 22.5 tons / 221 kN

## ■ Crimping Capacity:

- Max. Crimping Capacity : 630 mm<sup>2</sup>
- Compatible with all dies used for Alcoa, Burndy, T&B, Klauke, Cembre and Blackburn
- CU 400 / 500 / 630 dies included (See page 156)
- Available for 12 ton die when used with Adapter (ADP-630THE)
- 12 ton dies sold separately.

## ■ Features:

- Simple U-type head design is solid and durable.
- Lock pin design holds die firmly in place.
- Operated by any hydraulic pump with rated oil pressure of 700 bar (10,000 psi).
- Single action cylinder with spring return.

## ■ Accessories:

Plastic carrying case (See page 218)



## ■ Model No. **ADP-630HE**

This adapter is designed for hydraulic compression head HYCP-630HE to interchange with die sets from other 12-ton tools (up to 400 mm<sup>2</sup>)



※ Crimping without die sets is prohibited.



## ■ Model No. **HYCP-451000HE**

Height : 285 mm

Weight : 11.6 kgs

### ■ Specifications:

Max. Pressure : 700 bar

Oil Required : 226 cc

Max. Output : 44.5 tons / 436 kN

Ram Stroke : 35.5 mm

### ■ Crimping Capacity:

- Max. Crimping capacity: 1000 mm<sup>2</sup>
- Customized die sets can be ordered
- CU 400/500/630/800/1000 sold separately (See page 156)

### ■ Features:

- U-type head design is solid and durable.
- Lock pin design holds die firmly in place .
- Operated by any hydraulic pump with rated oil pressure of 700 bar (10,000 psi).
- Single action cylinder with spring return.

### ■ Accessories:

Plastic carrying case (See page 218)



## ■ Model No. **ADP-451000HE**

This adapter is designed for hydraulic compression head HYCP-451000HE to interchange with die sets from other 12-ton tools (up to 400 mm<sup>2</sup>)



※ Crimping without die sets is prohibited.



## ■ Model No. **HYCP-500HE**

Height : 380 mm

Weight : 17.1 kgs

## ■ Specifications:

Max. Pressure : 700 bar

Oil Required : 133 cc

Max. Output : 31 tons / 304 kN

Ram Stroke : 30 mm

## ■ Crimping Capacity:

- Max. Crimping capacity : 500 mm<sup>2</sup>

	JIS	AWG	DIN
<b>AL</b>	520	1000	500
<b>CU</b>	520	1000	500
<b>ACSR</b>	520	1000	500

- Copper lugs up to 500 mm<sup>2</sup>  
Aluminum lugs up to 590 mm<sup>2</sup>
- Die sets sold separately (See page 157)

## ■ Features:

- Yoke-type head design is solid and durable
- Convenient handle makes handling and hoisting easier.
- Positive die locking mechanism holds dies firmly in place.
- Operated by any hydraulic pump with rated oil pressure of 700 bar (10,000 psi).
- Single action cylinder with spring return.

## ■ Accessories:

Metal Case





## ■ Model No. **HYCP-60ST**

Height : 446 mm

Weight : 21.3 kgs

## ■ Specifications:

Max. Pressure : 700 bar

Oil Required : 308 cc

Max. Output : 55 tons / 539 kN

Ram Stroke : 38.7 mm

## ■ Crimping Capacity:

- Crimping Range : up to 60mm O.D. Sleeve
- Accepts all dies used for Alcoa, 60 ton compressors
- Single-Acting hydraulic pump required
- Dies are manufactured on request only (See page 157)

## ■ Features:

- Operated by any hydraulic pump with rated oil pressure of 700 bar (10,000 psi).
- Single action cylinder with spring return.
- Detachable ground stand as a standard accessory.
- Large handle for easy carrying.
- Removable die cap for easy connector positioning.
- Solid metal loop at base for hoist work.
- Compression head is designed as a portable tool for installing compression sleeves and terminals for transmission construction and/or maintenance work.

## ■ Accessories:

Metal Case



※ Crimping without die sets is prohibited.



## ■ Model No. **HYCP-60D**

Height : 446 mm

Weight : 23.3 kgs

## ■ Specifications:

Max. Pressure : 700 bar

Oil Required : 298 cc

Max. Output : 55 tons / 539 kN

Ram Stroke : 38 mm

## ■ Crimping Capacity:

- Crimping Range : up 60mm O.D.Sleeve
- Accepts all dies used for Alcoa, 60 ton compressors
- Double-Acting hydraulic pump required
- Dies are manufactured on request only (See page 157)

## ■ Features:

- Solid metal loop at base for hoist work.
- Ram retracts hydraulically ; the ram retracting time is 1/3 of spring return.
- Operated by any double-acting hydraulic pump with rated oil pressure of 700 bar (10,000psi).
- Detachable ground stand as a standard accessory.
- Large handle for easy carrying.
- Compression head is designed as a portable tool for installing compression sleeves and terminals for transmission construction and/or maintenance work.

## ■ Accessories:

Metal Case

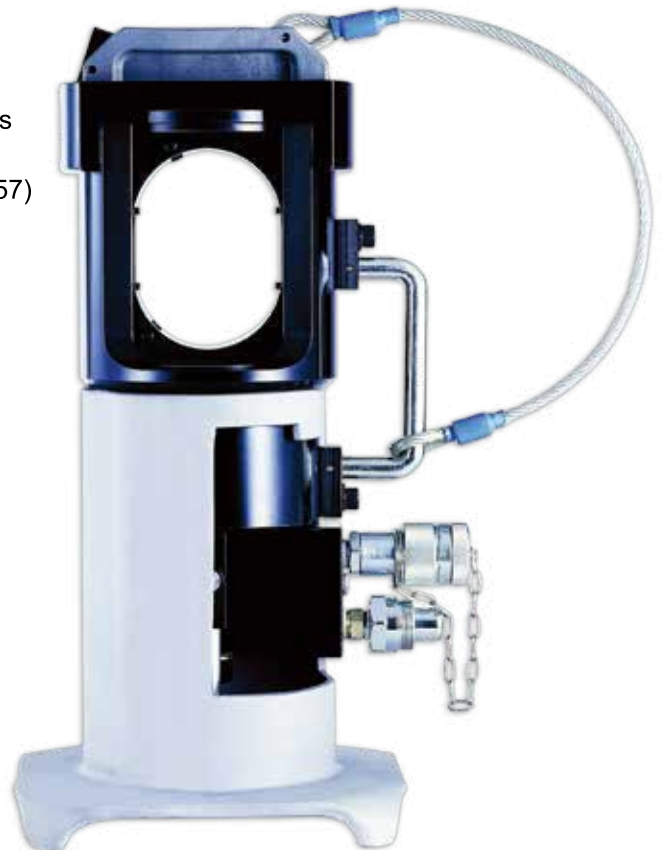

※ Crimping without die sets is prohibited.





## ■ Model No. **UA-100STS**

Height : 378 mm  
Weight : 36.0 kgs

## ■ Specifications:

Max. Pressure : 700 bar  
Oil Required : 420 cc  
Max Output : 100 tons / 980 kN  
Ram Stroke : 29.5 mm

## ■ Crimping Capacity:

- Crimping Range:
  - Copper : up to 64 mm O.D.Sleeve
  - Aluminum : up to 71 mm O.D.Sleeve
  - Steel : up to 32 mm O.D.Sleeve
- Double-Acting hydraulic pump required

## ■ Features:

- Operated by any double-acting hydraulic pump with rated oil pressure of 700 bar (10,000 psi).
- Functional handles for easy carrying and repositioning.
- Removable die cap for easy connector positioning.
- Ram retracts hydraulically; the ram retracting time is 1/3 of spring return.
- Compression head is designed as a portable tool for installing compression sleeves and terminals for transmission construction and / or maintenance work.

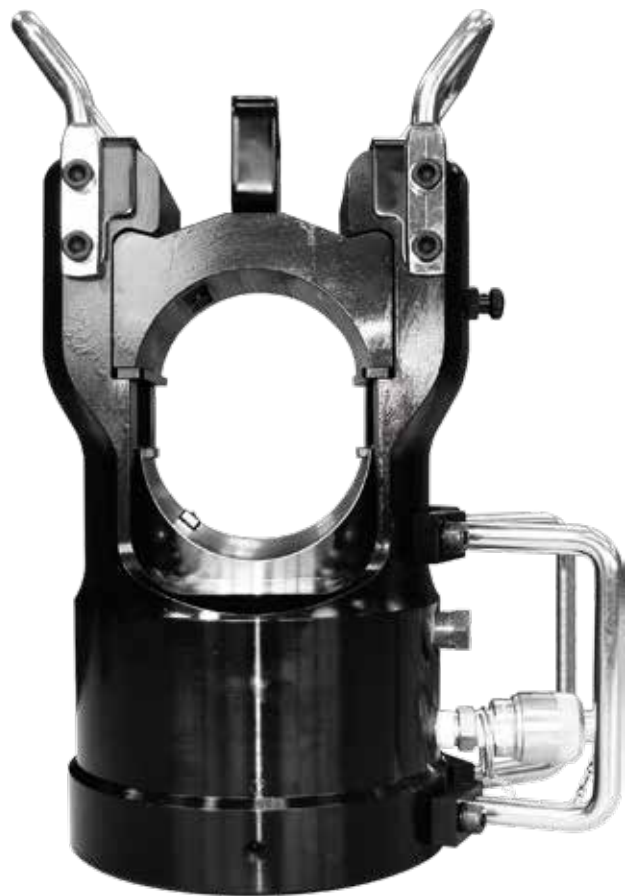

※ Crimping without die sets is prohibited.



# COMPRESSION HEAD

## ■ Model No. **UA-100ST**



Height : 378 mm  
Weight : 37.6 kgs

## ■ Specifications:

Max. Pressure : 700 bar  
Oil Required : 420 cc  
Max Output : 100 tons / 980 kN  
Ram Stroke : 29.5 mm

## ■ Crimping Capacity:

- Crimping Range:
  - Copper : up to 64 mm O.D.Sleeve
  - Aluminum : up to 71 mm O.D.Sleeve
  - Steel : up to 32 mm O.D.Sleeve
- Double-Acting hydraulic pump required

## ■ Features:

- Operated by any double-acting hydraulic pump with rated oil pressure of 700 bar (10,000 psi).
- Functional handles for easy carrying and repositioning.
- Removable die cap for easy connector positioning.
- Ram retracts hydraulically; the ram retracting time is 1/3 of spring return.
- Compression head is designed as a portable tool for installing compression sleeves and terminals for transmission construction and / or maintenance work.



※ Crimping without die sets is prohibited.



## ■ Model No. **SR-100C**

Height : 364 mm

Weight : 31.4 kgs

## ■ Specifications:

Max. Pressure : 700 bar

Oil Required : 318 cc

Max. Output : 100 tons / 980 kN

Ram Stroke : 22 mm

## ■ Crimping Capacity:

• Crimping Range:

Copper : up to 64 mm O.D.Sleeve

Aluminum : up to 71 mm O.D.Sleeve

Steel : up to 32 mm O.D.Sleeve

• Double-Acting hydraulic pump required

• Dies are manufactured on request only (See page 158)

## ■ Features:

- Operated by any double-acting hydraulic pump with rated oil pressure of 700 bar (10,000 psi).
- Functional handles for easy carrying and repositioning.
- Removable die cap for easy connector positioning.
- Ram retracts hydraulically ; the ram retracting time is 1/3 of spring return.
- Compression head is designed as a portable tool for installing compression sleeves and terminals for transmission construction and/ or maintenance work.



**HYCP-100ST**

※ Crimping without die sets is prohibited.



## ■ Model No. 100W

Height : 378 mm  
Weight : 33.8 kgs

## ■ Specifications:

Max. Pressure : 700 bar  
Oil Required : 385 cc  
Max Output : 100 tons / 980 kN  
Ram Stroke : 26.9 mm

## ■ Crimping Capacity:

- Crimping Range:
  - Copper : up to 64 mm O.D.Sleeve
  - Aluminum : up to 71 mm O.D.Sleeve
  - Steel : up to 32 mm O.D.Sleeve
- Double-Acting hydraulic pump required
- Dies are manufactured on request only (See page 158)

## ■ Features:

- Operated by any double-acting hydraulic pump with rated oil pressure of 700 bar (10,000 psi).
- Functional handles for easy carrying and repositioning.
- Removable die cap for easy connector positioning.
- Ram retracts hydraulically; the ram retracting time is 1/3 of spring return.
- Compression head is designed as a portable tool for installing compression sleeves and terminals for transmission construction and / or maintenance work.



※ Crimping without die sets is prohibited.



## ■ Model No. 200W

Height: 445 mm

Weight: 78 kgs

## ■ Specifications:

Max. Pressure : 700 bar

Oil Required : 1049 cc

Max. Output : 200 tons / 1960 kN

Ram Stroke : 37 mm

## ■ Crimping Capacity:

- Crimping Range :
  - Copper : up to 86 mm O.D.Sleeve
  - Aluminum : up to 100 mm O.D.Sleeve
  - Steel : up to 50 mm O.D.Sleeve
- Double-Acting hydraulic pump required
- Dies are manufactured on request only or current die set available sold separately (See page 158)

## ■ Features:

- Operated by any double-acting hydraulic pump with rated oil pressure of 700 bar (10,000 psi).
- Functional handles for easy carrying and repositioning.
- Removable die cap for easy connector positioning.
- Ram retracts hydraulically ; the ram retracting time is 1/3 of spring return.
- Compression head is designed as a portable tool for installing compression sleeves and terminals for transmission and/ construction or maintenance work.



※ Crimping without die sets is prohibited.



■ For LEC-U27, LEC-32, LEC-40, LEC-44, UB-400(HE), UCP-2712(HE), UB-412(HE), H-412HE, HYCP-4413(HE), ADP-15THE, ADP-630HE, ADP-451000HE

• Hex Dies for Copper Lugs

Suitable for TERMINALS with wall thickness little less than DIN 46235 Cable Lugs

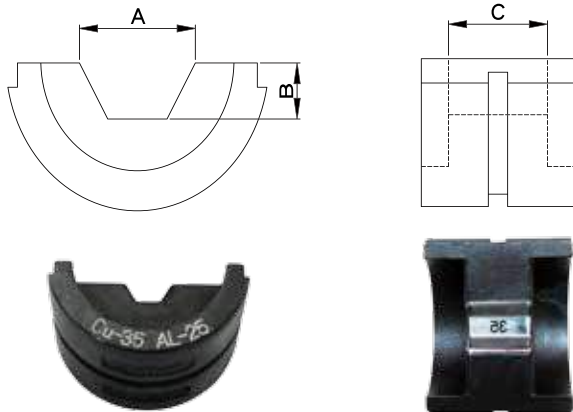

Unit: mm

Die No.	A	B	C
CU-16	7.20	3.12	14.00
CU-25	8.43	3.67	14.00
CU-35	10.00	4.33	16.00
CU-50	11.60	5.02	16.00
CU-70	13.70	5.95	15.60
CU-95	15.90	6.85	15.70
CU-120	17.98	7.79	16.00
CU-150	20.10	8.70	15.00
CU-185	22.33	9.67	14.00
CU-240	25.43	11.01	13.00
CU-300	28.44	12.32	11.20
CU-400	30.00	14.55	11.50

• Hex Dies for Solderless Terminals

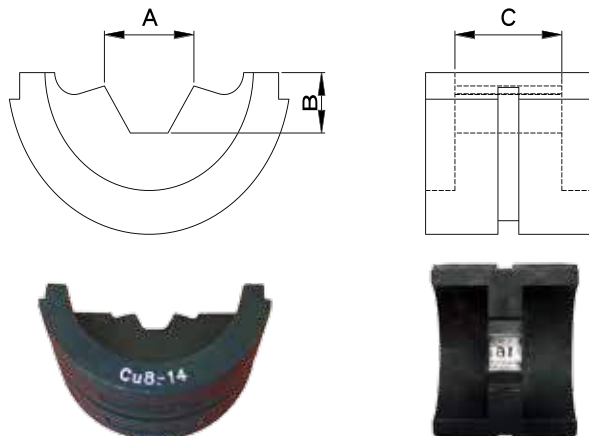

Unit: mm

Die No.	A	B	C
CU-8-14	7.40	3.50	8.00
CU-22	8.80	4.30	10.00
CU-38	11.50	5.40	11.50
CU-60-70	13.40	6.00	15.00
CU-80	15.00	6.75	18.00
CU-100	18.00	8.00	15.00
CU-150-180	21.00	9.10	13.00
CU-200	28.44	12.32	11.20
CU-325	30.00	14.56	11.50

■ For LEC-185T, LEC-240T, K-185, K-240, HYCP-185(HE), HYCP-240(HE)

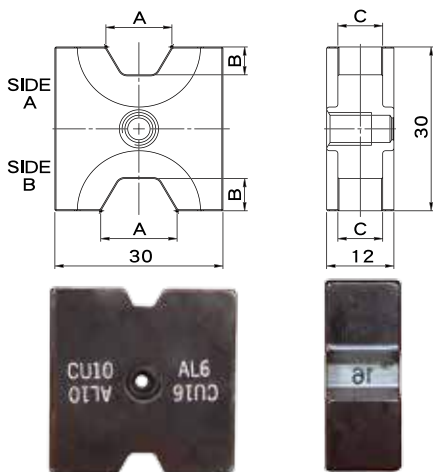

Unit: mm

Die No.	Side		A	B	C
AHE-1016	A	CU10	5.45	2.30	12.00
	B	CU16	6.80	2.85	12.00
AHE-2535	A	CU25	8.35	3.50	9.00
	B	CU35	9.40	4.00	9.00
AHE-5070	A	CU50	11.35	4.80	9.00
	B	CU70	13.80	6.05	9.00
AHE-95120	A	CU95	16.17	6.90	9.00
	B	CU120	18.05	7.60	9.00
AHE-150	A	CU150	20.15	8.55	6.00
AHE-185	A	CU185	22.15	9.35	6.00
AHE-240	A	CU240	22.15	9.35	6.00

• AHE-240 Die For 240 Series Only.



## ■ DIES FOR LEC-240, K-PH240, PH-240(HE) DIN (CU) 46235 DIN (AL) 46267

DIE NO.	Cross the flats dimension (MM)	Height (MM)	SIZE
T-16	7.01	6.40	8 CU 16 / AL10
T-25	8.18	7.60	10 CU 25 / AL16
T-35	10.09	9.50	12 CU 35 / AL25
T-50	11.69	11.00	14 CU 50 / AL35
T-70	13.42	12.00	16 CU 70 / AL50
T-95	15.59	14.60	18 CU 95 / AL70
T-120	17.15	16.00	20 CU 120 / AL95
T-150	19.23	18.20	22 CU 150 / AL120
T-185	21.52	20.40	25 CU 185 / AL150
T-240	24.08	24.0	28 CU 240 / AL185

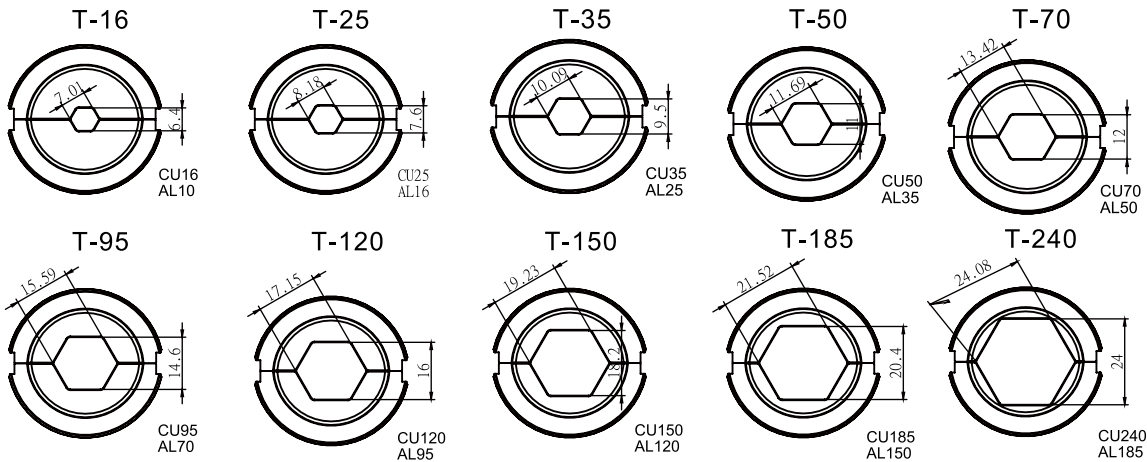

## ■ DIES FOR CRIMPING COLOR-CODED COPPER & ALUMINUM LUGS & SPLICES

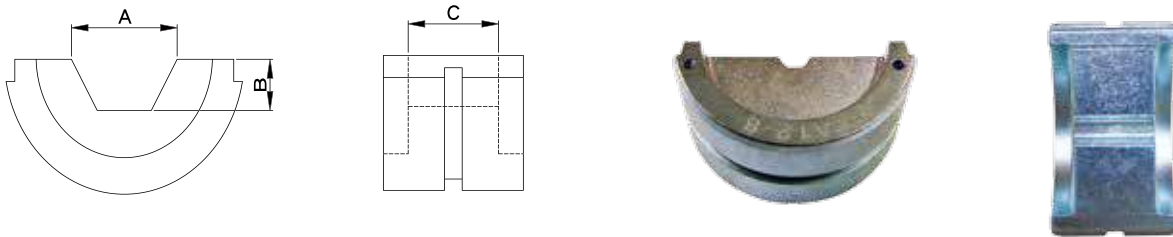

Unit: mm

"KA"STYLE DIES : ALUMINUM					
DIE NO.	A	B	C	CABLE SIZE	COLOR
KA12-8	5.68	2.26	16	8 AWG	Blue
KA12-4/0	20.08	8	16	4/0 AWG	White
KA12-250	21.96	8.76	16	250 kcmil (MCM)	Red
KA12-300	23.8	9.5	19	300 kcmil (MCM)	Blue
KA12-350	27.72	11.05	19	350 kcmil (MCM)	Brown
KA12-400	28.02	11.18	16	400 kcmil (MCM)	Green
KA12-500	30.25	12.45	16.26	500 kcmil (MCM)	Pink
KA12-600	33.66	13.97	16.26	600 kcmil (MCM)	Black
KA12-750	35.81	14.73	16.26	750 kcmil (MCM)	Yellow

# CRIMPERS DIES

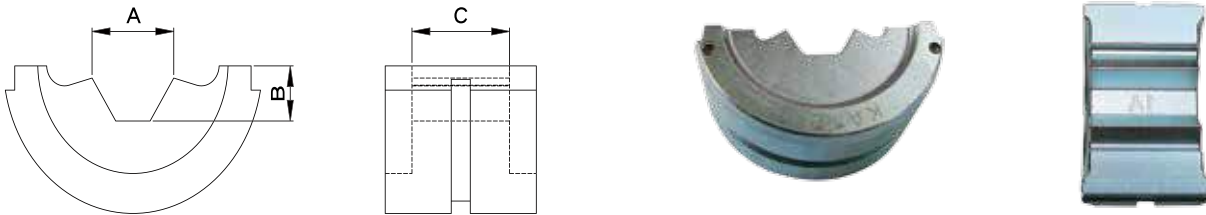

Unit: mm

"KA" STYLE DIES : ALUMINUM					
DIE NO.	A	B	C	CABLE SIZE	COLOR
KA12-6	7.29	2.92	16	6 AWG	Gray
KA12-4	8.79	3.81	16	4 AWG	Green
KA12-2	10.47	4.57	16	2 AWG	Pink
KA12-1	11.57	5	22.5	1 AWG	Gold
KA12-1/0	12.78	5.59	22.5	1/0 AWG	Tan
KA12-2/0	14.43	6.25	13	2/0 AWG	Olive
KA12-3/0	15.70	6.86	13	3/0 AWG	Ruby

## ■ DIES FOR CRIMPING COLOR-CODED COPPER & ALUMINUM LUGS & SPLICES

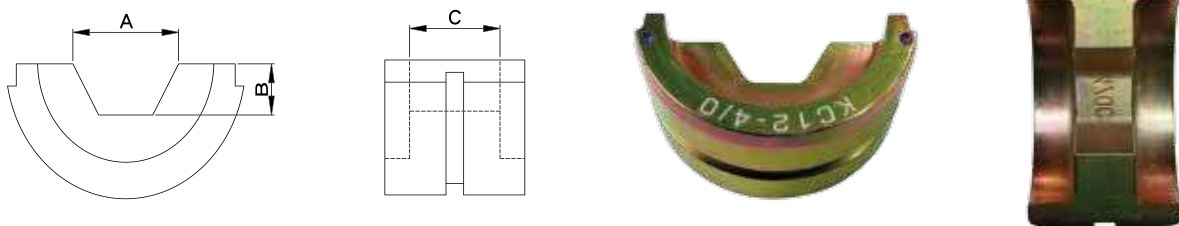

Unit: mm

"KC" STYLE DIES : COPPER					
DIE NO.	A	B	C	CABLE SIZE	COLOR
KC12-8	11.44	4.94	8	8 AWG	Gray
KC12-6	10.38	4.5	8	6 AWG	Blue
KC12-4	8.7	4.94	8	4 AWG	Gray
KC12-2	7.14	4.5	8	2 AWG	Brown
KC12-1	5.87	2.54	8	1 AWG	Green
KC12-1/0	12.7	5.5	10	1/0 AWG	Pink
KC12-2/0	13.9	6.02	10	2/0 AWG	Black
KC12-3/0	14.97	6.48	10	3/0 AWG	Orange
KC12-4/0	16.78	7.26	10	4/0 AWG	Purple
KC12-250	18.03	7.8	10	250 kcmil (MCM)	Yellow
KC12-300	19.84	8.59	10	300 kcmil (MCM)	White
KC12-350	21.65	9.37	10	350 kcmil (MCM)	Red
KC12-400	22.49	9.7	10	400 kcmil (MCM)	Blue
KC12-500	25.99	11.25	10	500 kcmil (MCM)	Brown
KC12-600	28.64	12.4	10	600 kcmil (MCM)	Green
KC12-750	30.26	13.1	10	750 kcmil (MCM)	Black

■ **DIES FOR USE WITH SERVICE ENTRANCE CONNECTORS, C-TAPS, H-TAPS, OVERHEAD AND UNDERGROUND CONNECTORS**

DIE NO.	BURNDY NO	DIE NO.	BURNDY NO	DIE NO.	BURNDY NO	DIE NO.	BURNDY NO
KD12-10	U-BG	KD12-11	U-O	KD12-12	U-C	KD12-14	U-161
KD12-15	U-162	KD12-16	U-163	KD12-17	U-165	KD12-18	U-166
KD12-19	U-243	KD12-20	U-247	KD12-21	U-249	KD12-30	U-D3
KD12-31	U-E	KD12-32	U-F	KD12-33	U-997	KD12-35	U-238
KD12-36	U-654	KD12-37	U-655	KD12-38	U-658	KD12-39	U-659
KD12-40	U-998						

## ■ For LEC-U240, UCP-240(HE)

DIE NO.	A	B	C	D	E	F
UCP240-14	19	8	7.2	—	—	—
UCP240-15	14	5.5	7.2	9	3	7.2
UCP240-16	25	10	7.2	—	—	—

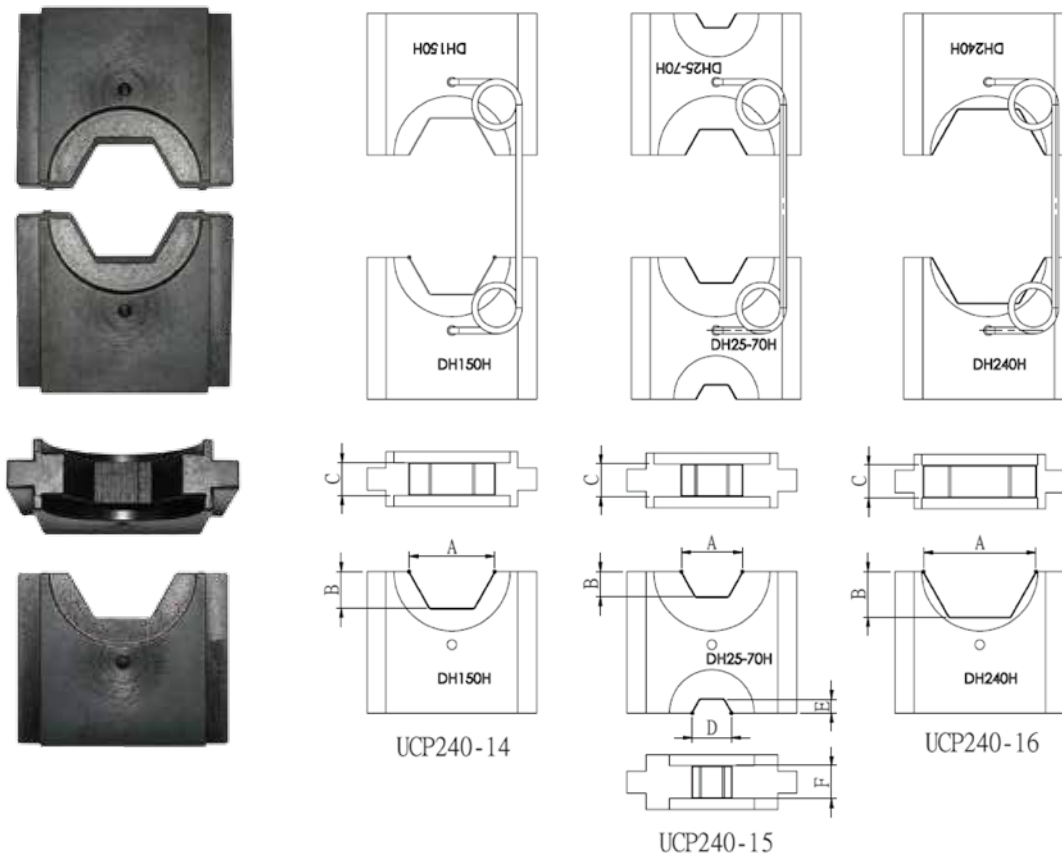

## ■ For HYCP-15THE

- Hex Dies for Copper tubular sleeves and lugs, for crimping to copper cables, according to NFC 20.130 standard

DIE NO.	A	B	C
15THE-CU400	32.56	14.10	10.60
15THE-CU500	36.03	15.60	10.60
15THE-CU630	42.84	18.55	10.60

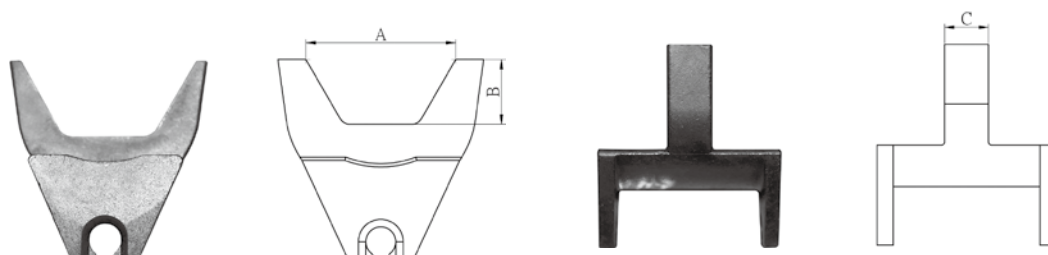

## ■ For HYCP-630HE

- Hex Dies for Copper tubular sleeves and lugs, for crimping to copper cables, according to NFC 20.130 standard

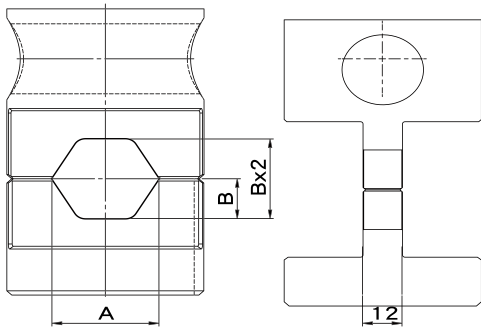

Unit : mm

Die No.	A	B
630HE-CU 400	32.56	14.10
630HE-CU 500	36.03	15.60
630HE-CU 630	42.84	18.55



## ■ For HYCP-451000HE

- Hex Dies for Copper tubular sleeves and lugs, for crimping to copper cables, according to NFC 20.130 standard

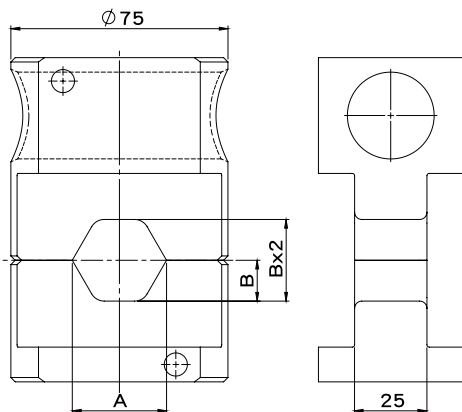

Unit : mm

Die No.	A	B
451000HE-CU 400	32.56	14.10
451000HE-CU 500	36.03	15.60
451000HE-CU 630	42.84	18.55
451000HE-CU 800	48.38	20.95
451000HE-CU 1000	52.77	22.85



## ■ For HYCP-500HE

- Hex Dies for Copper & Aluminum Conductors  
Suitable for JIS C2804 terminals

Unit : mm

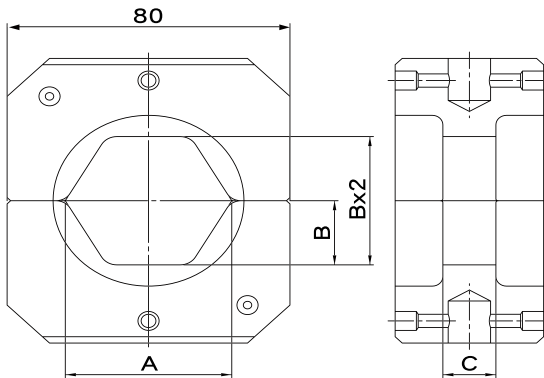

Die No.	A	B	C
500HE-160AI	28.75	12.70	50
500HE-150CU	32.56	14.10	30
500HE-400CU	33.14	14.35	30
500HE-500CU	36.72	15.90	30
500HE-500AI	52.20	22.85	50
500HE-800AI	56.80	24.85	50



### FOR STEEL SLEEVE

C : Die Width

Die No.	A	B	C
500HE-S17.4	17.40mm	7.53mm	42mm
500HE-S18.5	18.50mm	8.01mm	42mm
500HE-S21	21mm	8.74mm	12mm

### FOR ALUMINUM SLEEVE

C : Die Width

Die No.	A	B	C
500HE-L37	37mm	16.02mm	42mm
500HE-L46	46mm	19.92mm	42mm
500HE-L54	54mm	22.95mm	42mm

## ■ For HYCP-60ST / HYCP-60D DIES

(image and figure for reference only)

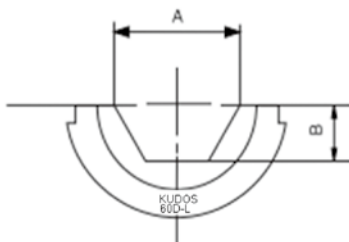

### FOR STEEL SLEEVE

unit: mm

DIE NO.	A	B	C
60G-14	13.90	5.95	37.10
60G-16	15.85	6.80	33.10
60G-18	17.90	7.60	29.40
60G-20	19.80	8.60	30.20
60G-22	21.80	9.25	23.10
60G-24	23.90	10.25	22.10
60G-26	25.85	11.00	20.10
60G-28	27.65	11.80	20.10
60G-30	29.70	12.70	20.20

### FOR ALUMINUM SLEEVE

unit: mm

DIE NO.	A	B	C
60L-21	21.00	9.00	19.00
60L-28.62	28.62	12.00	43.00
60L-31.77	31.77	13.13	57.00
60L-32	31.35	13.60	59.00
60L-34	33.45	14.40	58.20
60L-36	35.40	15.20	55.10
60L-38	37.35	16.10	51.90
60L-40	39.40	17.00	49.30
60L-42	41.90	17.90	46.90
60L-45	44.30	19.20	44.10
60L-48	47.25	20.45	41.10
60L-50	49.20	21.30	40.20
60L-52	51.25	22.10	37.40
60L-55	54.25	23.45	39.75

■ **For SR-100C / HYCP-100ST / 100W DIES**

(image and figure for reference only)

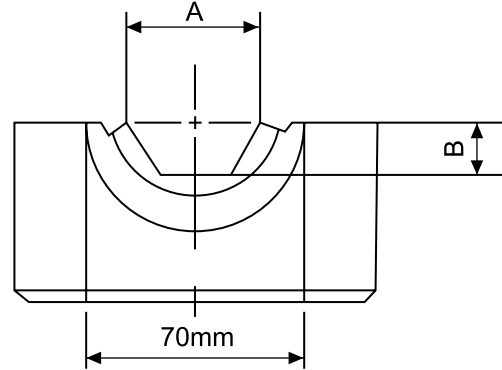

**FOR STEEL SLEEVE**

C : Die Wdth

Die No.	A	B	C
100ST-G12	12mm	5.20mm	40mm
100ST-G18	18mm	7.80mm	35mm
100ST-G20	20mm	8.70mm	35mm
100ST-G22	22mm	9.50mm	35mm

**FOR ALUMINUM SLEEVE**

C : Die Wdth

Die No.	A	B	C
100ST-L24	24mm	10.50mm	75mm
100ST-L30	30mm	12.50mm	75mm
100ST-L40	40mm	17.50mm	75mm
100ST-L42	42mm	18.20mm	75mm
100ST-L45	45mm	20.50mm	75mm
100ST-L52	52mm	22.50mm	75mm

■ **For 200W DIES**

(image and figure for reference only)

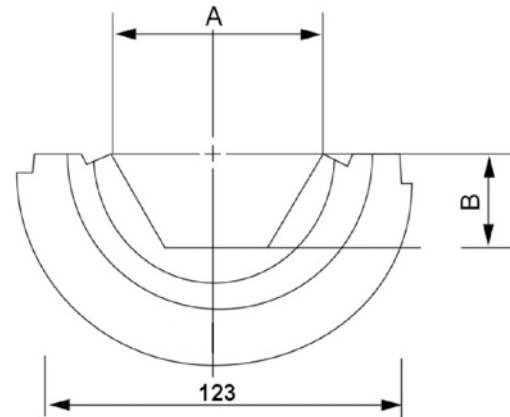

**FOR STEEL SLEEVE**

C : Die Wdth

Die No.	A	B	C
200W-G24	24mm	10.40mm	60mm

**FOR ALUMINUM SLEEVE**

C : Die Wdth

Die No.	A	B	C
200W-L24	24mm	10.40mm	128mm
200W-L32	32mm	14.10mm	128mm
200W-L70	70mm	30.70mm	128mm

## ■ Die Sets for HEC-U27、UCP-2712

Die Holder	Die (Indent Crimp)		Indentor
[ 1 ]	[ 2 ]	[ 5 ]	[ 6 ]
DH27-150	RU27-35	CD27-35	AI27-35
	RU27-95	CD27-95	AI27-95
DH27-240	RU27-150	CD27-150	AI27-150
	RU27-240	CD27-240	AI27-240

## ■ Pre-Rounders Selection

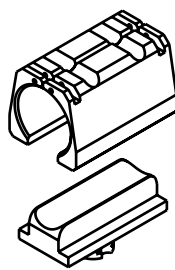
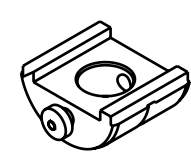
Aluminum Conductor Size (mm <sup>2</sup> )	Pre-Rounder [ 2 ] + [ 3 ]		Die Support [ 4 ]
			
25	RU27-35	RL27-25	DS27-P
35		RL27-35	
50	RU27-95	RL27-50	
70		RL27-70	
95		RL27-95	
120	RU27-150	RL27-120	
150		RL27-150	
185	RU27-240	RL27-185	
240		RL27-240	

## ■ Die Sets for HEC-U27

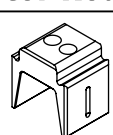
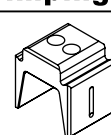
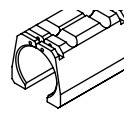
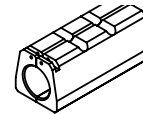
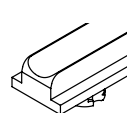
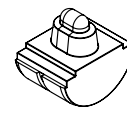
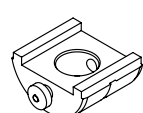
Conductor Rounding	Crimping	Description
[ 1 ] 	[ 1 ] 	[1] Die Holder [2] Pre-Rounders (Upper die) [3] Pre-Rounders (Lower die) [4] Die Support [5] Containing Die [6] E Indentor
[ 2 ] 	[ 5 ] 	
[ 3 ] 	[ 6 ] 	
[ 4 ] 		



## ■ Model No. **DC-15**

• (L) 300 mm x (W) 70 mm x (H) 210 mm

■ For 12 ton crimping dies up to 15 sets.

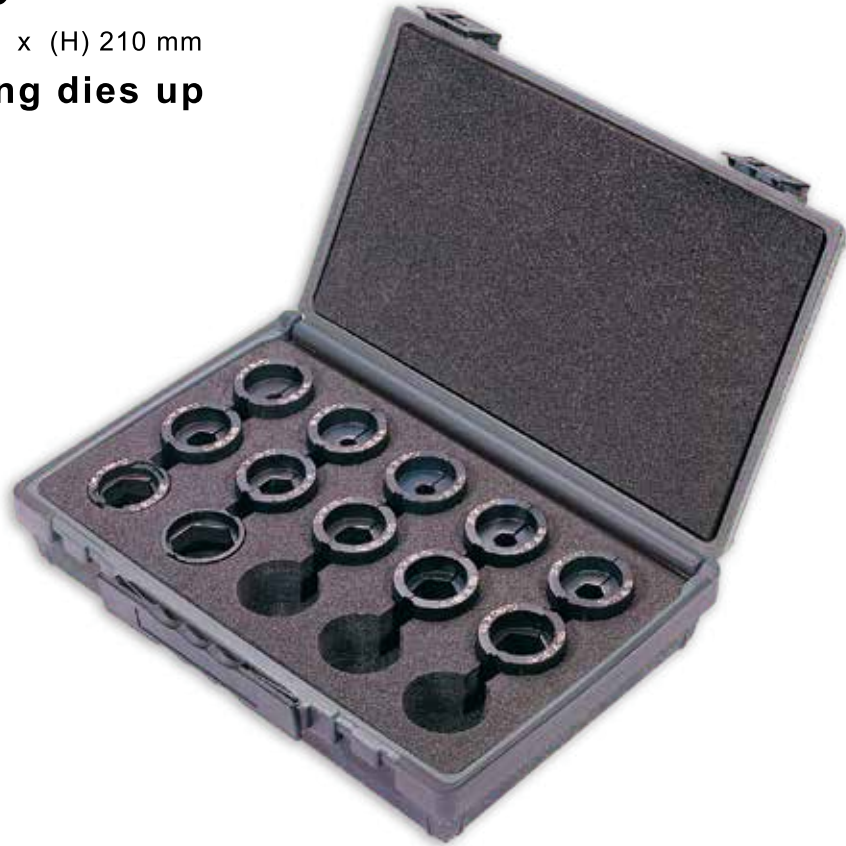

## ■ Model No. **DC-06**

• (L) 140 mm x (W) 55 mm x (H) 110 mm

■ For 12 ton crimping dies up to 6 sets.



# PUNCHERS & BENDERS

## ■ Model No. DRCP-559140

Length : 111 cm

Weight : 12 kgs

### ■ Cutting Capacity:

- Suitable for cutting 5 different shapes of DIN-rail sections without burrs or deformation.
- Ruler and Stopper are supplied with this tool.
- This tool can punch 8.8 mm x 5 mm holes along or perpendicular to the axis of the rail.

### ■ Features:

- Fast and easy cutting of DIN-rails for mounting electric components free of burrs.
- Delivered complete with a length stop gauge and punch set for mounting-holes.

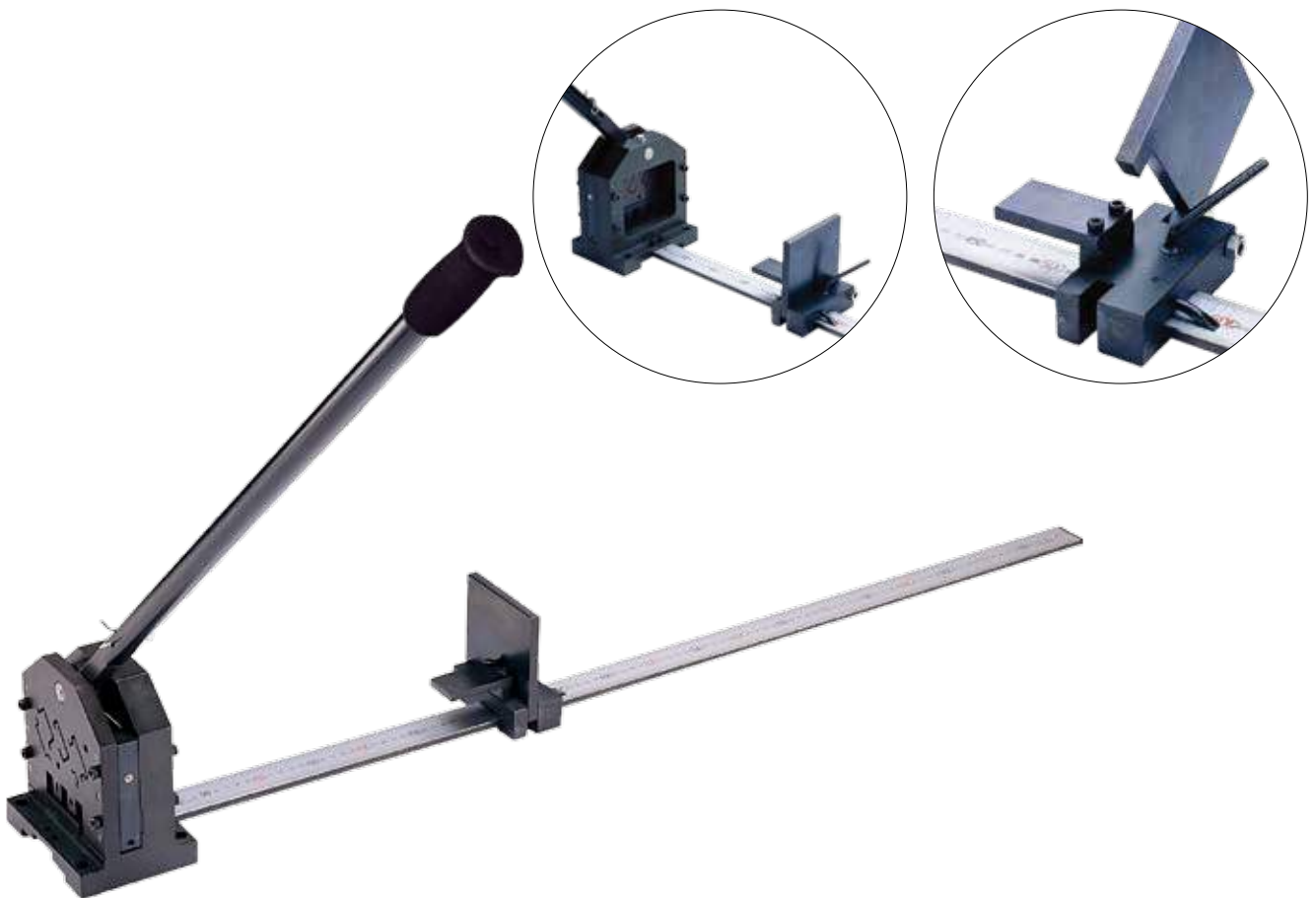
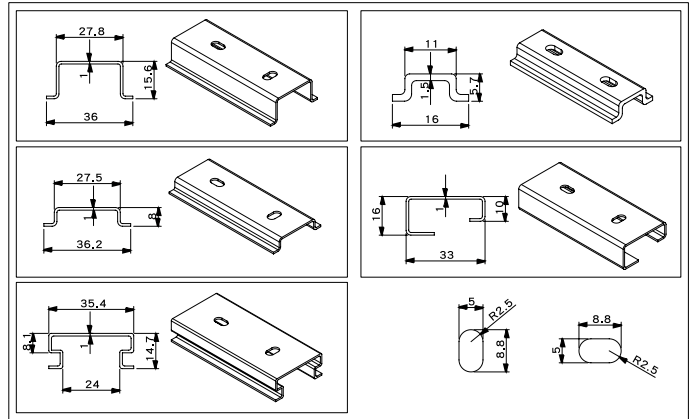

## ■ Model No. **PNST-10 / PNST-10M**

Weight : 7.6 kgs

### ■ Punching Capacity:

- Max. Thickness:  
Stainless Steel : 1.6 mm  
Mild Steel : 3.2 mm
- Max. Diameter : 4 inch
- 4 inch diameter hole on 3.2 mm thickness mild steel

### ■ Features:

- Suitable to punch holes in electrical panels, switchboards and others.
- Single action cylinder with spring release.
- Fast, easy, and simple to operate.
- Compact design makes this a perfect choice for use on construction sites and maintenance jobs.
- Powerful 12.7 ton hydraulic ram.



## ■ Accessories:

Model No.	Accessories	
PNST-10	<ul style="list-style-type: none"> <li>• HP-180N</li> <li>• PDV-10</li> <li>• Draw Stud (3/4", 3/8")</li> <li>• Spacer (S, M, L)</li> <li>• Plastic Case</li> </ul>	<p>6 Punch Die Sets: 1/2", 3/4", 1", 1-1/4", 1-1/2", 2"</p>
PNST-10M	<ul style="list-style-type: none"> <li>• HP-180N</li> <li>• PDV-10</li> <li>• Draw Stud (3/4", 3/8")</li> <li>• Spacer (S, M, L)</li> <li>• Plastic Case</li> </ul>	<p>6 Punch Die Sets: 16mm, 20mm, 25mm, 32mm, 40mm, 50mm</p>

- Do not use HP-180N with any compression head that requires a relief valve to ensure a constant compression.

## ■ Punch Driver : PDV-10

Ram Stroke : 25 mm  
Oil Required : 47 cc  
Max. Output : 12.7 tons / 125 kN

## ■ Packaging :

plastic carrying case



## ■ Model No. **PN-052 / PN-052M**

Height : 125 mm

Weight : 7.6 kgs

### ■ Punch Driver: **PDV-10**

Ram Stroke : 25 mm

Oil Required : 47 cc

Max. Output : 12.7 tons / 125 kN

### ■ Punching Capacity:

- Max. Thickness:
  - Stainless Steel : 1.6 mm
  - Mild Steel : 3.2 mm
- Max. Diameter : 4 inch
- 4 inch diameter hole on 3.2 mm thickness mild steel
- Single action cylinder with spring release

### ■ Features:

- Suitable to punch holes in electrical panels, switchboards and others.
- Fast, easy and simple to operate.
- Compact design makes this a perfect choice for use on construction sites and maintenance jobs.
- Powerful 12.7 ton hydraulic ram.



### ■ Accessories:

Model No.	Accessories	
PN-052	<ul style="list-style-type: none"> <li>• PDV-10</li> <li>• Draw Stud (3/4", 3/8")</li> <li>• Spacer (S, M, L)</li> <li>• Plastic Case</li> </ul>	<p><b>6 Punch Die Sets:</b></p> <p>1/2", 3/4", 1", 1-1/4", 1-1/2", 2"</p>
PN-052M	<ul style="list-style-type: none"> <li>• PDV-10</li> <li>• Draw Stud (3/4", 3/8")</li> <li>• Spacer (S, M, L)</li> <li>• Plastic Case</li> </ul>	<p><b>6 Punch Die Sets:</b></p> <p>16mm, 20mm, 25mm, 32mm, 40mm, 50mm</p>



## ■ Model No. **PN-254**

Weight : 11 kgs

### ■ **PUNCH SET**

- Use to punch electrical panels, switchboards and others.
- Maximum panel thickness: 3.2 mm mild steel.
- Can be operated by the Punch Driver PDV-10.
- Complete with a metal carry case.

Include:

Punch die: 2 $\frac{1}{2}$ " , 3" , 3 $\frac{1}{2}$ " , 4"  
total 4 sets.

2 pcs of draw stud. (3/4" , 3/8")



## ■ Model No. SH-70A

Height : 371 mm

Weight : 13 kgs

## ■ Specifications:

Throat Depth : 70 mm

Max. Pressure : 700 bar

Oil Required : 76 cc

Max. Output : 31 tons / 305 kN

## ■ Punching Capacity:

- Max. Thickness : 10 mm
- Max. Diameter : 20.5 mm
- 20.5 mm diameter hole with 10 mm thick mild steel
- For angle iron, plates, beams and bus bars

## ■ Features:

- C-Head made by forging for greater strength.
- Convenient handle for easy carrying.
- Base stand for easy positioning and accurate punching.
- Single action piston/cylinder arrangement reduces iron chippings.
- Punch and die changeover tools included.
- Operated by any hydraulic pump with rated oil pressure of 700 bar (10,000 psi).
- Efficient and safe to use.

## ■ Accessories:

Round Punching Dies for mild steel  
(10.5, 13.5, 17.5, 20.5 mm)

Hand Pin, 4 mm T-type Wrench



## Other Punching Die Option :



Square Punching Dies :  
5/16" 、 3/8" 、 7/16" 、 1/2"



Oval Punching Dies :  
5/16" 、 3/8" 、 7/16" 、 1/2"

## ■ Model No. **HYBC-120**

Height : 410 mm

Weight : 14.8 kgs

### ■ Specifications:

Max. Pressure : 700 bar

Oil Required : 131 cc

Max. Output : 21.9 tons / 215 kN

### ■ Cutting Capacity:

- Max. Width : 120 mm
- Max. Thickness : 12 mm
- Suitable materials : Aluminum, Copper, Iron

### ■ Features:

- Vertical stand ideally suited for cutting solid copper and aluminum bus bars.
- Level and precise cut.
- Great cutting capacity.
- Single action cylinder can be uncoupled from the cutting unit.
- The cylinder can also be connected to our bus bar bending model HYBN-120.
- Operated by any hydraulic pump with rated oil pressure of 700 bar (10,000 psi).





## ■ Model No. **BC160-27**

Height : 425 mm

Weight : 19.6 kgs

### ■ Specifications:

Max. Pressure : 700 bar

Oil Required : 162 cc

Max. Output : 27 tons / 264.6 kN

### ■ Cutting Capacity:

- Max. Width : 160 mm
- Max. Thickness : 12 mm
- Materials : Aluminum, Copper, Iron

### ■ Features:

- Vertical stand ideally suited for cutting solid copper and aluminum bus bars.
- Level and precise cut.
- Great cutting capacity.
- Single action cylinder can be uncoupled from the cutting unit.
- Operated by any hydraulic pump with rated oil pressure of 700 bar (10,000 psi).

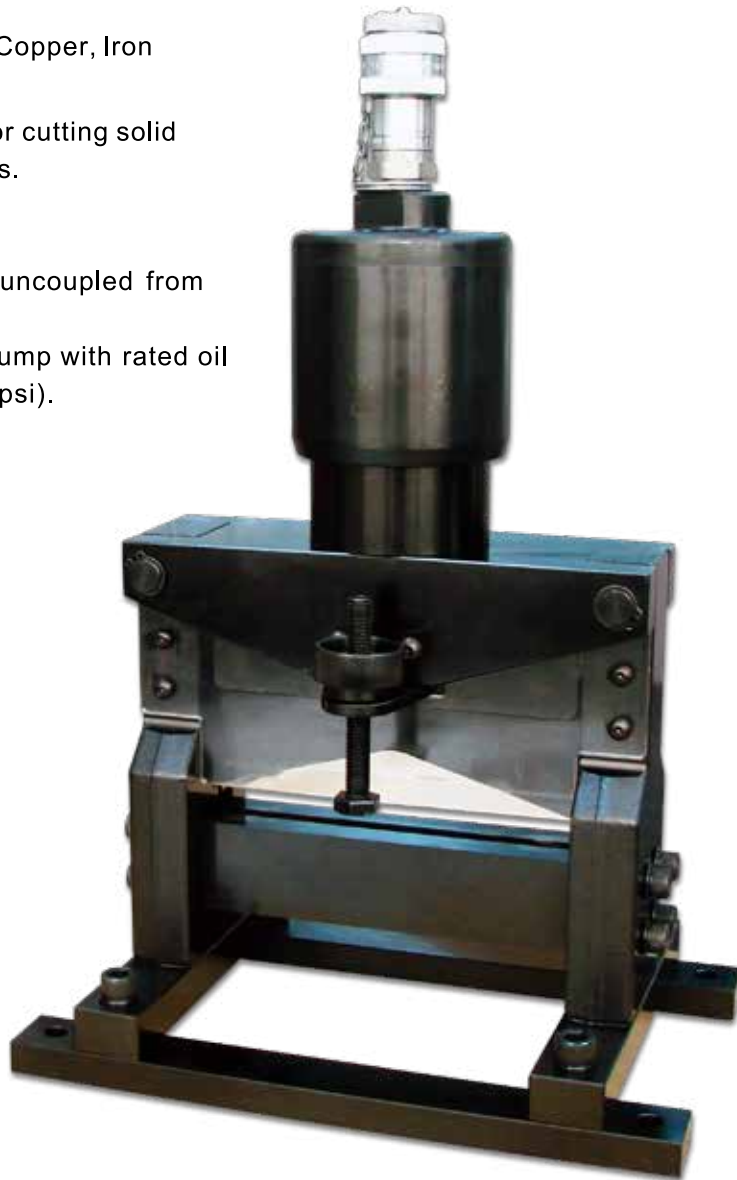

## ■ Model No. **ASC-7510**

Height : 425 mm

Weight : 22 kgs

### ■ Specifications:

Max. Pressure : 700 bar

Oil Required : 353 cc

Max. Output : 39 tons / 382.2 kN

Effective Stroke : 62.2 mm

### ■ Cutting Capacity:

- Max. Width : 75 mm
- Max. Thickness : 9 mm
- Materials : stainless steel, Iron

### ■ Features:

- Vertical stand ideally suited for cutting angled stainless steel.
- Level and precise cut.
- Great cutting capacity.
- Single action cylinder can be uncoupled from the cutting unit.
- Operated by any hydraulic pump with rated oil pressure of 700 bar (10,000 psi).



**MANUAL**  
Follow User Guide

**MAINTAIN**  
Maintain Regularly

**PROTECTION**  
Put On Goggles

**PROTECTION**  
Work With Gloves

## ■ Model No. **HDBC-16**

Height : 458 mm

Weight : 28 kgs

### ■ Specifications:

Max. Pressure : 700 bar

Oil Required : 176 cc

Max. Output : 27 tons / 264.6 kN

### ■ Cutting Capacity:

- Max. Width : 160 mm
- Max. Thickness : 15 mm
- Materials : Aluminum, Copper, Iron

### ■ Features:

- Vertical stand ideally suited for cutting solid copper and aluminum bus bars.
- Level and precise cut.
- Great cutting capacity.
- Single action cylinder can be uncoupled from the cutting unit.
- Operated by any hydraulic pump with rated oil pressure of 700 bar (10,000 psi).



## ■ Model No. **HYBN-120**

Height : 360 mm

Weight : 15.8 kgs

### ■ Specifications:

Max. Pressure : 700 bar

Oil Required : 124 cc

Max. Output : 21.9 tons / 215 kN

Effective stroke : 130 mm

### ■ Bending Capacity:

- Max. Width : 120 mm
- Max. Angle : 90 degree
- Max. Thickness : 12 mm
- Bending materials : Aluminum, Copper

### ■ Features:

- Vertical stand ideally suited for bending solid copper and aluminum bus bars.
- 2 lateral parallel-stops for exact angular positioning of bus bars.
- Convenient scale for reading the current bending angle.
- Single action cylinder can be uncoupled from the bending unit.
- The cylinder can also be connected to our bus bar cutting model HYBC-120.
- Operated by any hydraulic pump with rated oil pressure of 700 bar (10,000 psi).



## ■ Model No. **DBBN-120**

Height : 360 mm

Weight : 15.8 kgs

### ■ Specifications:

Max. Pressure : 700 bar

Oil Required : 124 cc

Max. Output : 21.9 tons / 215 kN

Effective stroke : 130 mm

### ■ Bending Capacity:

- Max. Width : 120 mm
- Max. Angle : 90 degree
- Max. Thickness : 12 mm
- Suitable materials : Aluminum, Copper

### ■ Features:

- Vertical stand ideally suited for bending solid copper and aluminum bus bars.
- 2 lateral parallel-stops for exact angular positioning of bus bars.
- Convenient scale for reading the current bending angle.
- Single action cylinder can be uncoupled from the bending unit.
- The cylinder can also be connected to our bus bar cutting model HYBC-120.
- Operated by any hydraulic pump with rated oil pressure of 700 bar (10,000 psi).



## ■ Model No. **HYBN-160**

Height : 360 mm

Weight : 18.8 kgs

### ■ Specifications:

Max. Pressure : 700 bar

Oil Required : 130 cc

Max. Output : 21.9 tons / 215 kN

Effective stroke : 160 mm

### ■ Bending Capacity:

- Max. Width : 160 mm
- Max. Angle : 90 degree
- Max. Thickness : 12 mm
- Bending materials : Aluminum, Copper

### ■ Features:

- Vertical stand ideally suited for bending solid copper and aluminum bus bars.
- 2 lateral parallel-stops for exact angular positioning of bus bars.
- Convenient scale for reading the current bending angle.
- Single action cylinder can be uncoupled from the bending unit.
- The cylinder can also be connected to our bus bar cutting model HYBC-160.
- Operated by any hydraulic pump with rated oil pressure of 700 bar (10,000 psi).



# PIPE BENDER

## ■ Model No. **PB-10N**

Length : 780 mm

Weight : 18.6 kgs

## ■ Specifications:

Max. Pressure : 700 bar

Oil Required : 400 cc

Max. Output : 11.1 tons / 110 kN

Ram Stroke : 250 mm

Max. Bending : 90 degrees

## ■ Bending Capacity:

Thin Steel Conduit : 15mm-75mm (5/8")-(3")

Thick Steel Conduit : 16mm-82mm (1/2")-(3")

Gas Pipe : 15mm-65mm (1/2")-(2 1/2")

## ■ Features:

- Compatible with all bending shoes designed to bend JIS standardized conduit pipe and gas pipe.
- Designed to bend various sizes and thicknesses of steel pipe.
- Makes smooth, wrinkle-free bends.
- Bending frame and pivot shoes are lightweight, heat-treated aluminum.
- Operated by any hydraulic pump with rated oil pressure of 700 bar (10,000 psi).

## ■ Accessories:

Aluminum Frame

Single action hydraulic cylinder

2 Pivot shoes





## ■ Features

The PB-10N was designed to bend various sizes and various thickness of steel pipes without wrinkles. An aluminum alloy frame makes this bender lighter so that it can be easily carried to the job site. Bending shoes are designed to bend JIS standardized conduit pipe and gas pipe listed in left chart. If the pipe outer diameter being bent is equivalent to the one from the chart, the shoe can be used for thg application.

## ■ Remarks

Hydraulic pump & Bending shoes are sold separately.

Bending Shoe

Thin conduit (A) Thick conduit (B)

Gas pipe (SGP)

Unit: mm

Size	Pipe dia	Size	Pipe dia	Size	Pipe dia	Size	Pipe dia
A15	15.9	A63	63.5	B42	47.8	SGP-25	34.0
A19	19.1	A75	76.2	B54	59.6	SGP-32	42.7
A25	25.4	B16	21.0	B70	75.2	SGP-40	48.6
A31	31.8	B22	26.5	B82	87.9	SGP-50	60.5
A39	38.1	B28	33.3	SGP-15	21.7	SGP-65	76.3
A51	50.8	B36	41.9	SGP-20	27.2		

## ■ Model No. Bending Angle Gauge

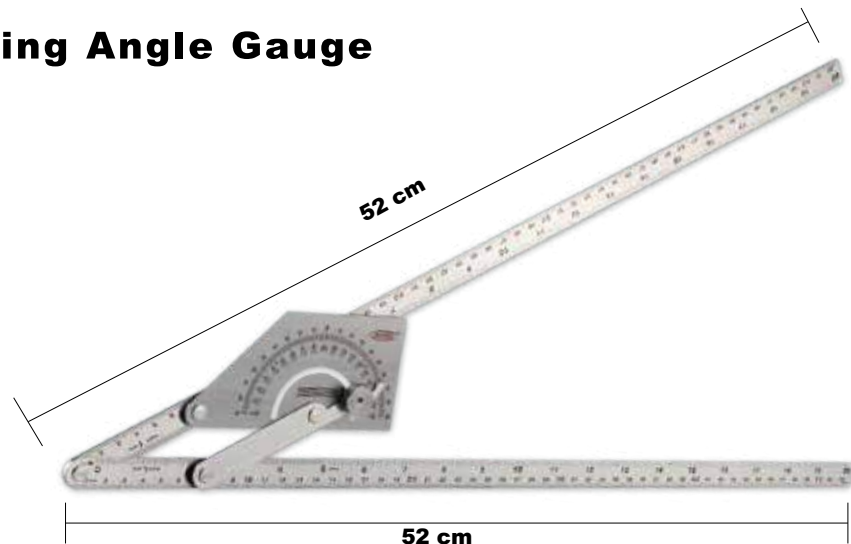

## ■ HYNC-SERIES(Single Blade)



### ■ Features:

- Compact design.
- Easy to use.
- Seven models of nut splitter to choose from.
- Unique angled head design for a variety of applications.
- Single action cylinder with hydraulic advance with spring-return.
- Operated by any hydraulic pump with rated oil pressure of 700 bar (10,000 psi).

### ■ Specifications:Single Blade Type

Model No.	Bolt Range	Hex Nut Range (mm)	Capacity (ton)	Oil Capacity (cm <sup>3</sup> )	Dimensions (mm)			Net Weight (kg)	Gross Weight (kg)
					Length	Width	Height		
HYNC-1319	M6-M12	10-19	5	15	170	40	48	1.2	2.6
HYNC-1924	M12-M16	19-24	10	20	191	54	62	2.0	3.6
HYNC-2432	M16-M22	24-32	15	60	222	64	72	3.0	5.2
HYNC-3241	M22-M27	32-41	20	80	244	75	88	4.4	7.0
HYNC-4150	M27-M33	41-50	35	155	288	94	105	8.2	13.6
HYNC-5060	M33-M39	50-60	50	240	318	106	128	11.8	18.4
HYNC-6075	M39-M48	60-75	90	492	393	156	181	34.1	42.7

### ■ Dimensions:

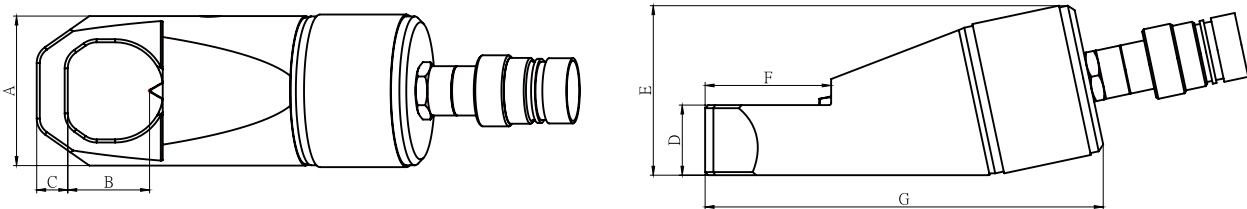

Unit: mm

Model No.	A	B	C	D	E	F	G	Spare Chisels No.	
HYNC-1319	40	21	7	19	50	29	120	HYNC-1319 #4	Chisel
HYNC-1924	54	25	10	25	62	40	146	HYNC-1924 #4	Chisel
HYNC-2432	64	33	13	30	76	52	180	HYNC-2432 #4	Chisel
HYNC-3241	70	42	16	36	87	65	205	HYNC-3241 #4	Chisel
HYNC-4150	90	52	21	45	108	76	245	HYNC-4150 #4	Chisel
HYNC-5060	106	60	24	54	125	92	288	HYNC-5060 #4	Chisel
HYNC-6075	156	80	27	75	184	110	365	HYNC-6075 #4	Chisel

- **Caution** : Only suitable for ≤ grade 8 nuts, splitting of stainless, square, and / or star nuts are prohibited. Nut hardness must not exceed HRc-44.



## ■ HYNC-SERIES(Double Blade)



### ■ Features:

- Compact design.
- Easy to use.
- Seven models of nut splitter to choose from.
- Unique angled head design for a variety of applications.
- Single action cylinder with hydraulic advance with spring-return.
- Operated by any hydraulic pump with rated oil pressure of 700 bar (10,000 psi).
- One extra blade to advance the cut.

### ■ Specifications:Double Blade

Model No.	Bolt Range	Hex Nut Range (mm)	Capacity (ton)	Oil Capacity (cm <sup>3</sup> )	Dimensions (mm)			Net Weight (kg)	Gross Weight (kg)
					Length	Width	Height		
HYNC-1319D	M6-M12	10-19	5	15	223	44	67	1.3	2.8
HYNC-1924D	M12-M16	19-24	10	20	250	56	74	2.4	3.8
HYNC-2432D	M16-M22	24-32	15	60	275	64	78	3.5	5.4
HYNC-3241D	M22-M27	32-41	20	80	305	77	90	5.1	7.2
HYNC-4150D	M27-M33	41-50	35	155	344	97	111	9.7	13.8
HYNC-5060D	M33-M39	50-60	50	240	386	115	131	14.7	18.6
HYNC-6075D	M39-M48	60-75	90	492	476	170	186	40.7	42.9

### ■ Dimensions:

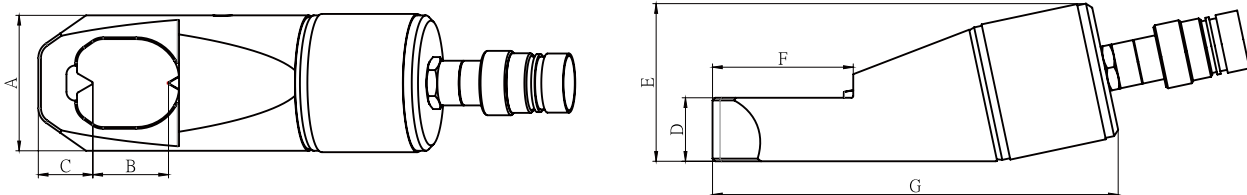

Unit: mm

Model No.	A	B	C	D	E	F	G	Spare Chisels No.	
HYNC-1319D	40	21	18	19	53	41	139	HYNC-1319D #7、#10	Chisel
HYNC-1924D	54	26	22	25	66	50	168	HYNC-1924D #7、#10	Chisel
HYNC-2432D	64	34	26	30	78	65	198	HYNC-2432D #7、#10	Chisel
HYNC-3241D	77	43	31	36	90	80	231	HYNC-3241D #7、#10	Chisel
HYNC-4150D	94	52	39	45	111	93	271	HYNC-4150D #7、#10	Chisel
HYNC-5060D	106	32	43	54	131	107	315	HYNC-5060D #7、#10	Chisel
HYNC-6075D	156	77	54	75	186	133	411	HYNC-6075D #7、#10	Chisel

- **Caution** : Only suitable for ≤ grade 8 nuts, splitting of stainless, square, and / or star nuts are prohibited. Nut hardness must not exceed HRC-44.

# NUT SPLITTER

## ■ Accessories

Model No.	Hex Wrench (mm)	Packaging
HYNC-1319	2.5 & 4	KuDos® Plastic Carrying Case
HYNC-1924	3 & 5	
HYNC-2432	4 & 6	
HYNC-3241	4 & 6	
HYNC-4150	4 & 6	
HYNC-5060	5 & 6	Crate
HYNC-6075	5 & 6	

Model No.	Hex Wrench (mm)	Packaging
HYNC-1319D	2.5 & 4	KuDos® Plastic Carrying Case
HYNC-1924D	3 & 5	
HYNC-2432D	4 & 6	
HYNC-3241D	4 & 6	
HYNC-4150D	4 & 6	
HYNC-5060D	5 & 6	Crate
HYNC-6075D	5 & 6	



## ■ Model No. PF-1319

Length : 333 mm

Weight : 2.1 kgs

## ■ Specifications:

Max. Pressure : 600 bar

Oil Required : 17 cc

Max. Output : 5.7 tons / 55.86 kN

Bolting Range : M6~M12  
(Hex. Nut range : 10-19mm)

## ■ Bolting Capacity:

Jaw opening : 24.3 mm

Ram Stroke : 17.3 mm

## ■ Features:

- Light weight, compact and slim design.
- 180° degree rotating head for convenient operation.
- Single stage pumping .
- Relief valve.

## ■ Accessories:

Carrying Bag

## ■ Caution :

Only suitable for ≤ grade 8 nuts,  
splitting of stainless, square, and / or  
star nuts are prohibited.  
Nut hardness must not exceed HRc-44.



### Spare Chisel No.

PF-1319 #2

Chisel



# NUT SPLITTER

## ■ Model No. PF-2432

Length : 562 mm

Weight : 6.9 kgs

## ■ Specifications:

Max. Pressure : 700 bar

Oil Required : 47.5 cc

Max. Output : 16.6 tons / 162.6 kN

Bolting Range : M16~M22

(Hex. Nut range : 24-32mm)

## ■ Bolting Capacity:

Jaw opening : 33 mm

Ram Stroke : 20 mm

## ■ Features:

- Light weight, compact and slim design.
- 180° degree rotating head for convenient operation.
- Single stage pumping .
- Relief valve.

## ■ Accessories:

Carrying Bag

## ■ Caution :

Only suitable for ≤ grade 8 nuts, splitting of stainless, square, and / or star nuts are prohibited.

Nut hardness must not exceed HRc-44.



### Spare Chisel No.

PF-2432 #14

Chisel

## ■ Pumping Capacity Chart

Pump Model	Power Source	Stage		Valve Type		Valve		Oil Delivery		Oil Required	
		Single	Two	Single Acting	Double Acting	Manual	Solenoid	Low Pressure	High Pressure		
HP-180N	Manual	☉		☉		☉		0.9 cc / stroke (single stage only)		180 cc	
HYP-700FT			☉	☉		☉		35.8 cc / stroke	2.1 cc / stroke	720 cc	
HYP-700FTG			☉	☉			☉		35.8 cc / stroke	2.1 cc / stroke	720 cc
HP-700A				☉	☉		☉		12.26 cc / stroke	2.26 cc / stroke	720 cc
HP-700AG				☉	☉		☉		12.26 cc / stroke	2.26 cc / stroke	720 cc
HF-700				☉	☉		☉		12.26 cc / stroke	2.26 cc / stroke	720 cc
HF-700G				☉	☉		☉		12.26 cc / stroke	2.26 cc / stroke	720 cc
HP-30S				☉	☉		☉		12.26 cc / stroke	2.26 cc / stroke	3000 cc
HP-30MD				☉		☉	☉		12.26 cc / stroke	2.26 cc / stroke	3000 cc
CEP-15SS		Battery x 2	☉		☉				1.2L / min	0.3L / min	1500 cc
EP-30MS	Electric	☉		☉				2.6L / min	0.32L / min	3000 cc	
EP-30MD			☉		☉	☉		2.6L / min	0.32L / min	3000 cc	
EP-30S				☉	☉			☉	2.6L / min	0.32L / min	3000 cc
EP-76MS				☉	☉		☉		3.9L / min	0.2L / min	8000 cc
EP-76MD				☉		☉	☉		3.9L / min	0.2L / min	8000 cc
EP-76SD				☉		☉		☉	3.9L / min	0.2L / min	8000 cc
EP-76SS				☉	☉			☉	3.9L / min	0.2L / min	8000 cc
EP-76SSC				☉	☉			☉	3.9L / min	0.2L / min	8000 cc
GHP-5		Gasoline / Petrol		6.5HP		☉	☉		13.4L / min	2.4L / min	9500 cc
GHP-5W			6.5HP		☉	☉		13.4L / min	2.4L / min	9500 cc	
GHP-5SD			6.5HP		☉	☉		13.4L / min	2.4L / min	9500 cc	
EP-200SD	Electric		2HP		☉		☉	10.5L / min	1L / min	2000 cc	
EP-200SDCF			2HP		☉		☉	10.5L / min	1L / min	2000 cc	
EP-200MD			2HP		☉	☉		10.5L / min	1L / min	2000 cc	
EP-200MDCF			2HP		☉	☉		10.5L / min	1L / min	2000 cc	

## ■ Model No. **HP-180N**

Length : 320 mm

Weight : 3.7 kgs

## ■ Specifications:

Max. Pressure : 590 bar

Oil Required : 175 cc

## ■ Oil Delivery:

0.9 cc / stroke

## ■ Features:

- Ideal for our PNST-10 punch driver or any small remote heads requiring less than 180 cc oil volume.
- Bladder type oil reservoir allows operation in any position.
- Single stage pumping action.
- Not equipped with a relief valve.

## ■ Accessories:

1M hydraulic hose attached

### Note:

This pump does NOT have a relief valve. It can not be used with compression heads requiring a relief valve to ensure a constant compression.



## ■ Model No. **HYP-700FT**

Length : 720 mm

Weight : 12.0 kgs

### ■ Specifications:

Max. Pressure : 700 bar

Oil Required : 1000 cc

### ■ Oil Delivery:

35.8 cc / stroke at low pressure

2.1 cc / stroke at high pressure

### ■ Features:

- Dual speed pump piston for rapid advance.
- Two stage pumping action.
- External adjustable pressure setting up to 700 bar.
- Internal oil bladder type oil reservoir allows operation in any position.
- Replaceable dropout bypass valve cartridge for easy repair.
- Economical yet dependable foot hydraulic pump.

### ■ Accessories:

2M hydraulic hose attached



## ■ Model No. **HYP-700FTG**

Length : 720 mm  
Weight : 12.6 kgs

### ■ Specifications:

Max. Pressure : 700 bar  
Oil Required : 1000 cc

### ■ Oil Delivery:

35.8 cc / stroke at low pressure  
2.1 cc / stroke at high pressure

### ■ Features:

- Dual speed pump piston for rapid advance.
- Two stage pumping action.
- External adjustable pressure setting up to 700 bar.
- Internal oil bladder type oil reservoir allows operation in any position.
- Replaceable dropout bypass valve cartridge for easy repair.
- Economical yet dependable hydraulic foot pump.
- Attached with pressure gauge for pressure display.

### ■ Accessories:

2M hydraulic hose attached



※ Steel case colour for reference only.

● Pressure Gauge





## ■ Model No. HP-700A

Length : 595 mm

Weight : 9.0 kgs

### ■ Specifications:

Max. Pressure : 700 bar

Oil Required : 720 cc

### ■ Oil Delivery:

12.26 cc / stroke at low pressure

2.26 cc / stroke at high pressure

### ■ Features:

- Dual speed pump piston for rapid advance.
- Two stage pumping action
- External adjustable pressure setting up to 700 bar.
- Internal oil bladder type oil reservoir allows operation in any position.
- Replaceable dropout bypass valve cartridge for easy repair.
- Economical yet dependable hydraulic hand pump.

### ■ Accessories:

2M hydraulic hose attached



## ■ Model No. **HP-700AG**

Height : 647 mm  
Weight : 9.6 kgs

## ■ Specifications:

Max. Pressure : 700 bar  
Oil Required : 720 cc

## ■ Oil Delivery:

12.26 cc / stroke at low pressure  
2.26 cc / stroke at high pressure

## ■ Features:

- Dual speed pump piston for rapid advance.
- Two stage pumping action.
- External adjustable pressure setting up to 700 bar.
- Internal oil bladder type oil reservoir allows operation in any position.
- Replaceable dropout bypass valve cartridge for easy repair.
- Economical yet dependable hydraulic hand pump.
- Attached with pressure gauge for pressure display.

## ■ Accessories:

2M hydraulic hose attached



● Pressure Gauge



## ■ Model No. **HF-700**

Length : 694 mm

Weight : 9.4 kgs

### ■ Specifications:

Max. Pressure : 700 bar

Oil Required : 720 cc

### ■ Oil Delivery:

12.26 cc / stroke at low pressure

2.26 cc / stroke at high pressure

### ■ Features:

- Dual speed pump piston for rapid advance.
- Two stage pumping action.
- External adjustable pressure setting up to 700 bar.
- Internal oil bladder type oil reservoir allows operation in any position.
- Replaceable dropout bypass valve cartridge for easy repair.
- Economical yet dependable hydraulic hand pump.
- To comply with ergonomic design for hand and feet use.

### ■ Accessories:

2M hydraulic hose attached



## ■ Model No. HF-700G

Height : 656 mm  
Weight : 10.0 kgs

## ■ Specifications:

Max. Pressure : 700 bar  
Oil Required : 720 cc

## ■ Oil Delivery:

12.26 cc / stroke at low pressure  
2.26 cc / stroke at high pressure

## ■ Features:

- Dual speed pump piston for rapid advance.
- Two stage pumping action.
- External adjustable pressure setting up to 700 bar.
- Internal oil bladder type oil reservoir allows operation in any position.
- Replaceable dropout bypass valve cartridge for easy repair.
- Economical yet dependable hydraulic hand pump.
- To comply with ergonomic design for hand and foot use.
- Attached with pressure gauge for pressure display.

## ■ Accessories:

2M hydraulic hose attached



● Pressure Gauge



**MANUAL**  
Follow User Guide

**MAINTAIN**  
Maintain Regularly

**PROTECTION**  
Put On Goggles

**PROTECTION**  
Work With Gloves

**EASY**  
For Small Spaces

## ■ Model No. **HP-30S**

Length : 600 mm

Weight : 15.6 kgs

### ■ Specifications:

Max. Pressure : 700 bar

Oil Required : 3000 cc

### ■ Oil Delivery:

12.26 cc / stroke at low pressure

2.26 cc / stroke at high pressure

### ■ Features:

- Dual speed pump piston for rapid advance.
- Two stage pumping action .
- External adjustable pressure setting up to 700 bar.
- Economical yet dependable hydraulic hand pump.

### ■ Accessories:

2M hydraulic hose attached



## ■ Model No. **HP-30MD**

Length : 745 mm

Weight : 18.4 kgs

### ■ Specifications:

Max. Pressure : 700 bar

Oil Required : 3000 cc

### ■ Oil Delivery:

12.26 cc / stroke at low pressure

2.26 cc / stroke at high pressure

### ■ Features:

- Dual speed pump piston for rapid advance
- Two stage pumping action
- External adjustable pressure setting up to 700 bar
- Economical yet dependable hydraulic hand pump
- Attached with pressure gauge for pressure display

### ■ Accessories:

Hydraulic hose should be ordered separately



●Pressure Gauge





■ **Model No. CEP-15SS**

Height : 319 mm  
Weight : 8.5kg (w/o battery)  
Weight : 10kgs (with 2 batteries)

■ **Specifications:**

Max. Pressure : 700 bar  
Oil Required : 1500 cc

■ **Oil Delivery:**

1.2 L / min at low pressure  
0.3 L / min at high pressure

■ **Features:**

- Pressure and operation data of date by display function.
- Programming Switch for crimping, cutting or lifting propose on the panel.
- Warning Function: Buzzer alert at long deep if crimping not complete and losing pressure when failure caused.
- Display related pumping pressure and battery capacity.
- Environmentally design for saving energy as automatic switch to sleep mode after 3 mins without any activate action.
- Interior Counting function attached
- PSI / BAR unit available.
- Shoulder strap for high wearing comfort.

■ **Accessories:**

- 18V Battery 4.0Ah, 110V or 230V Charger.  
(See page 77)

■ **Hydraulic Symbol Table**

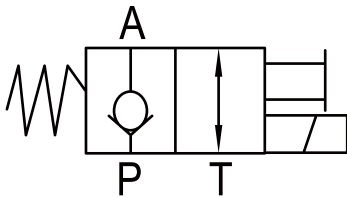

## ■ Close View of NEW CEP-15SS Features



- **Strap Installation**  
The battery-hydraulic pumps are ready to use for overhead operation with the secured strap as easy carrying propose.



- **Remote controller as optional operation mode.**



- **Operate with powerful, high-capacity Li-Ion batteries along and interchangeable of A \ B battery individual detect capacity.**



- **LCD display.**
- **Maintenance warning attached.**



- **Bosch battery power indicator 18V Li-ion battery.**



- **Room for remote control.**
- **Overload relay attached.**
- **Low-voltage protection for extending battery life cycle.**
- **Intelligent motor control brake.**
- **Maintenance warning attached.**





■ **Model No. EP-30MS**

Height : 454 mm  
Weight : 15 kgs (w/o oil)

■ **Specifications:**

Max. Pressure : 700 bar  
Oil Required : 3000 cc  
2 way, 2 position manual valve  
Drive unit : 220V/AC or 110V/AC \ 50/60Hz

■ **Oil Delivery:**

2.6 L / min at low pressure  
0.32 L / min at high pressure

■ **Features:**

- With 5 meter remote control cable provides the user complete control to advance and retract.
- Two speed high performance.
- Pressure holds at 700 bar, ideal for maintenance and construction.
- Equipped with large-capacity one piece metal oil tank.

■ **Accessories:**

Hydraulic hose should be ordered separately.

■ **Hydraulic Symbol Table**

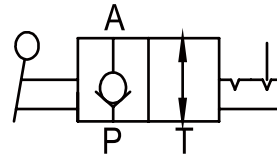

● Pressure Gauge



● Optional remote controller, shall order separately.



## ■ Model No. EP-30MD



Height : 454 mm  
Weight : 15 kgs (w/o oil)

### ■ Specifications:

Max. Pressure : 700 bar  
Oil Required : 3000 cc  
4 way, 3 position manual valve  
Drive unit : 220V/AC or 110V/AC \ 50/60Hz

### ■ Oil Delivery:

2.6 L / min at low pressure  
0.32 L / min at high pressure

### ■ Features:

- With 5 meter remote control cable provides the user complete control to advance and retract.
- Two speed high performance.
- Pressure holds at 700 bar, ideal for maintenance and construction.
- Equipped with large-capacity one piece metal oil tank.

### ■ Accessories:

Hydraulic hose should be ordered separately.

### ■ Hydraulic Symbol Table

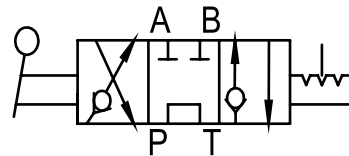

●Pressure Gauge



●Optional remote controller, shall order separately.



■ **Model No. EP-30S**

Height : 374 mm

Weight : 18.0 kgs (w/o oil)

■ **Specifications:**

Max. Pressure : 700 bar

Oil Required : 3000 cc

Input : Single phase 50/60Hz 110V 、 120V 、 220V 、 230V  
350W motor

■ **Oil Delivery:**

2.6 L / min at low pressure

0.32 L / min at high pressure

■ **Features:**

- Fully remote controlled, allows the operator to advance, hold or retract at any time.
- Two-stage pumping action.
- Cuts and crimps can be adjusted as necessary by stopping the advance or retract mode.
- 3/4 HP Heavy-Duty motor.
- Durable steel construction with built-in carrying handle.
- Low amperage requirement.
- Oil level is visible.

■ **Accessories:**

2M hydraulic hose attached

■ **Hydraulic Symbol Table**

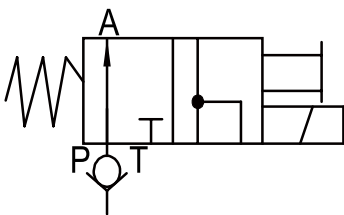

• Optional remote controller, shall order separately.



## ■ Model No. **EP-76MS**

Height : 480 mm

Weight : 20.0 kgs (w/o oil)

## ■ Specifications:

Max. Pressure : 700 bar

Oil Required : 8000 cc

2 way, 2 position manual valve

Drive unit : 220V/AC or 100V/AC 50/60Hz \ 1/2Hp

## ■ Oil Delivery:

3.9 L / min at low pressure

0.2 L / min at high pressure

## ■ Features:

- With 5 meter remote control cable provides the user complete control to advance and retract.
- Two speed high performance.
- Equipped with single-phase, thermal protected induction motor to reduce noise level.
- Pressure holds at 700 bar, ideal for maintenance and construction.
- Equipped with large-capacity one piece metal oil tank.

## ■ Accessories:

Hydraulic hose should be ordered separately.

## ■ Hydraulic Symbol Table

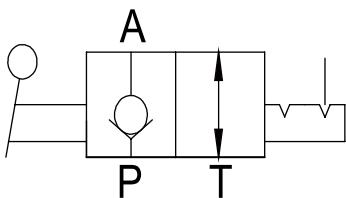

• Optional remote controller, shall order separately.



■ **Model No. EP-76MD**

Height : 480 mm

Weight : 25.0 kgs (w/o oil)

■ **Specifications:**

Max. Pressure : 700 bar

Oil Required : 8000 cc

4 way, 3 position manual valve

Drive unit : 220V/AC or 110V/AC 50/60Hz \ 1/2Hp

■ **Oil Delivery:**

3.9 L / min at low pressure

0.2 L / min at high pressure

■ **Features:**

- With 5 meter remote control cable provides the user complete control to advance and retract.
- Two speed high performance.
- Equipped with a thermal protected induction motor to reduce noise level.
- Pressure holds at 700 bar, ideal for maintenance and construction.
- Equipped with large-capacity one piece metal oil tank.

■ **Accessories:**

Hydraulic hose should be ordered separately.

■ **Hydraulic Symbol Table**

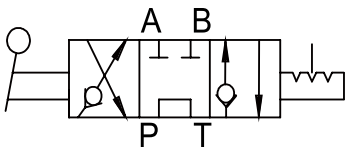

• Optional remote controller, shall order separately.



## ■ Model No. EP-76SD

Height : 480 mm

Weight : 25.0 kgs (w/o oil)

## ■ Specifications:

Max. Pressure : 700 bar

Oil Required : 8000 cc

4 way, 3 position solenoid valve

Drive unit : 110V/AC or 240V/AC 50/60Hz \ 1/2Hp \ 3600 rpm

## ■ Oil Delivery:

3.9 L / min at low pressure

0.2 L / min at high pressure

## ■ Features:

- With 5 meter remote control cable provides the user complete control to advance and retract.
- Two speed high performance.
- Equipped with a thermal protected induction motor to reduce noise level.
- Pressure holds at 700 bar, ideal for maintenance and construction.
- Equipped with large-capacity one piece metal oil tank.

## ■ Accessories:

Hydraulic hose should be ordered separately.

## ■ Hydraulic Symbol Table

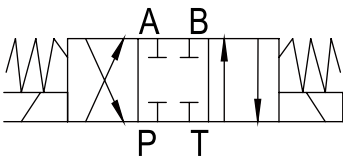

• Optional remote controller, shall order separately.



■ **Model No. EP-76SS**

Height : 480 mm

Weight : 25.0 kgs (w/o oil)

■ **Specifications:**

Max. Pressure : 700 bar

Oil Required : 8000 cc

3 way, 2 position solenoid valve

Drive unit : 220VAC 100V~120V 、 210V~240V 、 50 / 60Hz 、 1/2Hp

■ **Oil Delivery:**

3.9 L / min at low pressure

0.2 L / min at high pressure

■ **Features:**

- With 5 meter remote control cable provides the user complete control to advance and retract.
- Two speed high performance.
- Equipped with single-phase, thermal protected induction motor to reduce noise level.
- Pressure holds at 700 bar, ideal for maintenance and construction.
- Equipped with large-capacity one piece metal oil tank.

■ **Accessories:**

Hydraulic hose should be ordered separately.

■ **Hydraulic Symbol Table**

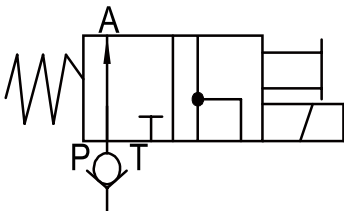

• Optional remote controller, shall order separately.



## ■ Model No. EP-76SSC

Height : 480 mm  
Weight : 25.2 kgs

## ■ Specifications:

Max. Pressure : 700 bar  
Oil Required : 8,000 cc  
3 way, 2 position solenoid valve  
Drive unit : 220VAC 100V~120V、210V~240V、50 / 60Hz、1/2Hp

## ■ Oil Delivery:

3.9 L / min at low pressure  
0.2 L / min at high pressure

## ■ Features:

- With 5 meter remote control cable provides the user complete control to advance and retract.
- Two speed high performance.
- Equipped with single-phase, thermal protected induction motor to reduce noise level.
- Pressure holds at 700 bar, ideal for maintenance and construction.
- Equipped with large-capacity one piece metal oil tank.

## ■ Accessories:

Hydraulic hose should be ordered separately.

## ■ Hydraulic Symbol Table

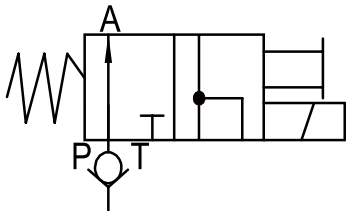

●Air-Cooled Heat Exchanger



●Pressure Gauge



●Pressure Adjuster



●Optional remote controller, shall order separately.





## ■ Model No. **GHP-5**

Height : 590 mm  
Weight : 58 kgs (with oil)

## ■ Specifications:

Max. Pressure : 700 bar  
Oil Required : 9.5 L  
Motor Size : 6.5 HP  
Valve type : 4-way, 3-position  
Motor Manufacturer : Honda  
Manually controlled engine

## ■ Oil Delivery:

13.4 L / min at low pressure  
2.4 L / min at high pressure

## ■ Features:

- Pressure gauge can be located in upright position for better reading.
- Equipped with a 4-way, 3-position manual valve to prevent the electric control valve being locked and not able to perform retire because of high temperature.
- Supplied with a rack with rollers.
- High efficiency and fast working gasoline pump.

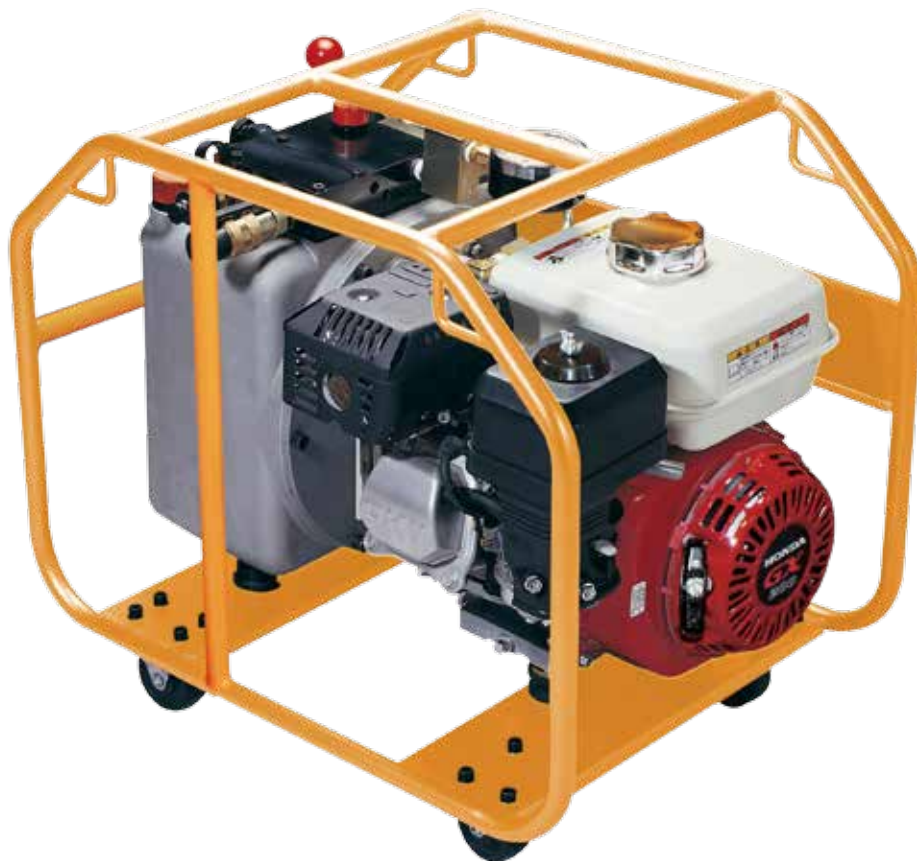

## ■ Model No. **GHP-5W**

Height : 606 mm  
Weight : 71.4 kgs (with oil)  
Weight : 19.8 kgs (Enlarged Wheel Accessory)

## ■ Specifications:

Max. Pressure : 700 bar  
Oil Required : 9.5 L  
Motor Size : 6.5 HP  
Valve type : 4-way, 3-position  
Motor Manufacturer : Honda  
Manually controlled engine

## ■ Oil Delivery:

13.4 L / min at low pressure  
2.4 L / min at high pressure

## ■ Features:

- Pressure gauge can be located in upright position for better reading.
- Equipped with a 4-way, 3-position manual valve to prevent the electric control valve being locked and not able to perform retire because of high temperature.
- Supplied with a rack with rollers.
- High efficiency and fast working gasoline pump.



■ GHP-5W Enlarged Wheel Accessory  
(Sold Separately)



- Improved design of enlarged tires to eliminate bumpy road



**MANUAL**  
Follow User Guide

**MAINTAIN**  
Maintain Regularly

**PROTECTION**  
Put On Goggles

**PROTECTION**  
Work With Glove

**EASY**  
For Small Space

**RELOAD**  
Back To Origin

■ **Model No. GHP-5SD**



Height : 667 mm  
Weight : 62 kgs (with oil)

■ **Specifications:**

Max. Pressure : 700 bar  
Oil Required : 9.5 L  
Motor Size : 6.5 HP  
Valve type : 4-way, 3-position Solenoid Valve  
Motor Manufacturer : Honda  
Manually controlled engine

■ **Features:**

- Pressure gauge located in upright position for better reading.
- Supplied with inflatable tires and rotated 360° front wheels for changing direction easily.
- High efficiency and fast working gasoline pump
- GHP-5SD permits the user to advance, hold and retract the ram at both single and double acting presses.
- Suitable for double acting compression heads used in transmission line stringing and maintenance or single acting compression heads for overhead work fields.

■ **Oil Delivery:**

13.4 L / min at low pressure  
2.4 L / min at high pressure

■ **Hydraulic Symbol Table**

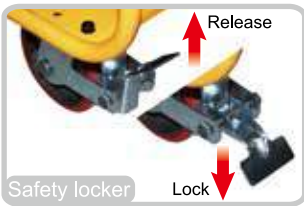
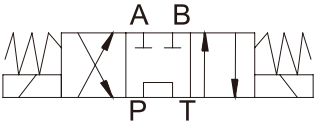

• Rotatable 360° front wheel, easy to change direction.



• Improved design of enlarged tires to eliminate bumpy road



• Optional remote controller, shall order separately.



## ■ Model No. **GHP-5SDRM**



Height : 667 mm  
Weight : 63 kgs (with oil)

### ■ Specifications:

Max. Pressure : 700 bar  
Oil Required : 9.5 L  
Motor Size : 6.5 HP  
Valve type : 4-way, 3-position Solenoid Valve  
Motor Manufacturer : Honda  
Manually controlled engine

### ■ Oil Delivery:

13.4 L / min at low pressure  
2.4 L / min at high pressure

### ■ Hydraulic Symbol Table

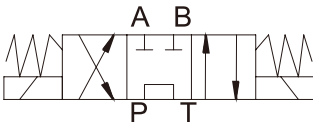

### ■ Features:

- Pressure gauge located in upright position for better reading.
- Supplied with inflatable tires and rotated 360° front wheels for changing direction easily.
- High efficiency and fast working gasoline pump
- GHP-5SD permits the user to advance, hold and retract the ram at both single and double acting presses.
- Suitable for double acting compression heads used in transmission line stringing and maintenance or single acting compression heads for overhead work fields.
- Radio Frequency remote controller is able to be used wireless at less 30 meters distance by its remote operation.



• Optional remote function (RF wireless remote / wire remote)

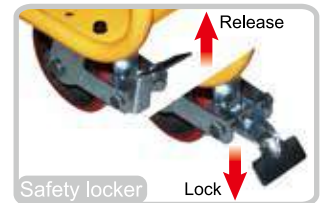

• Rotatable 360° front wheel, easy to change direction.



• Improved design of enlarged tires to eliminate bumpy road



• Optional remote controller, shall order separately.



■ **Model No. EP-200SD**

Height : 691 mm  
Weight : 78.4 kgs (w/o oil)  
Weight : 20.2 kgs (Enlarged Wheel Accessory)

■ **Specifications:**

Max. Pressure : 700 bar  
Oil Required : 20 L  
Motor Size : 2 HP  
Valve type : 4-way, 3-position Solenoid Valve  
Input : 220V / 230V

■ **Oil Delivery:**

10.5 L / min at low pressure  
1.0 L / min at high pressure

■ **Hydraulic Symbol Table**

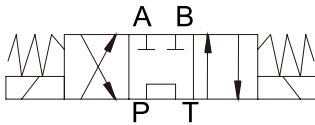

● Pressure Gauge



■ **Features:**

- With 5 Meter Remote control cable provides the user complete control to advance and retract.
- Easy to use by one button control to advance and retract pumping.
- Two stage pumping of high performance.
- Equipped with single-phase, thermal-protected motor to reduce noise level.
- Equipped with large capacity one piece metal oil tank.

■ **Accessories:**

Hydraulic hose & Cooler Device : single-phase 220V / Flow @ 30L / min should be ordered separately.



● Optional remote controller, shall order separately.



## ■ Model No. EP-200SDCF

Height : 691 mm  
 Weight : 84.5 kgs (w/o oil)  
 Weight : 20.2 kgs (Enlarged Wheel Accessory)

## ■ Specifications:

Max. Pressure : 700 bar  
 Oil Required : 20 L  
 Motor Size : 2 HP  
 Valve type : 4-way, 3-position Solenoid Valve  
 Input : 220V / 230V

## ■ Oil Delivery:

10.5 L / min at low pressure  
 1.0 L / min at high pressure

## ■ Hydraulic Symbol Table

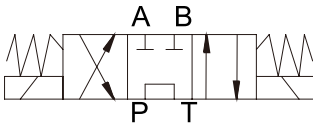

## ■ Features:

- With 5 Meter Remote control cable provides the user complete control to advance and retract.
- Easy to use by one button control to advance and retract pumping.
- Two stage pumping of high performance.
- Equipped with single-phase, thermal-protected motor to reduce noise level.
- Equipped with large capacity one piece metal oil tank.

## ■ Accessories:

Hydraulic hose & Cooler Device : single-phase 220V / Flow @ 30L / min should be ordered separately.



● Pressure Gauge



● Air-Cooled Heat Exchanger + Spin-On Return Filter



● Optional remote controller, shall order separately.



■ **Model No. EP-200MD**

Height : 691 mm  
Weight : 76.4 kgs (w/o oil)  
Weight : 20.2 kgs (Enlarged Wheel Accessory)

■ **Specifications:**

Max. Pressure : 700 bar  
Oil Required : 20 L  
Motor Size : 2 HP  
Valve type : 4-way, 3-position Manual Valve  
Input : 220V / 230V

■ **Oil Delivery:**

10.5 L / min at low pressure  
1.0 L / min at high pressure

■ **Hydraulic Symbol Table**

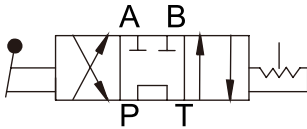

■ **Features:**

- With 5 Meter Remote control cable provides the user complete control to advance and retract.
- Easy to use by one button control to advance and retract pumping.
- Two stage pumping of high performance.
- Equipped with single-phase, thermal-protected motor to reduce noise level.
- Equipped with large capacity one piece metal oil tank.

■ **Accessories:**

Hydraulic hose & Cooler Device : single-phase 220V / Flow @ 30L / min should be ordered separately.



•Optional remote controller, shall order separately.



## ■ Model No. **EP-200MDCF**

Height : 691 mm  
Weight : 82.5 kgs (w/o oil)  
Weight : 20.2 kgs (Enlarged Wheel Accessory)

## ■ Specifications:

Max. Pressure : 700 bar  
Oil Required : 20 L  
Motor Size : 2 HP  
Valve type : 4-way, 3-position Manual Valve  
Input : 220V / 230V

## ■ Oil Delivery:

10.5 L / min at low pressure  
1.0 L / min at high pressure

## ■ Hydraulic Symbol Table

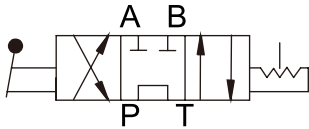

## ■ Features:

- With 5 Meter Remote control cable provides the user complete control to advance and retract.
- Easy to use by one button control to advance and retract pumping.
- Two stage pumping of high performance.
- Equipped with single-phase, thermal-protected motor to reduce noise level.
- Equipped with large capacity one piece metal oil tank.

## ■ Accessories:

Hydraulic hose & Cooler Device : single-phase 220V / Flow @ 30L / min should be ordered separately.



•Air-Cooled Heat Exchanger  
+  
Spin-On Return Filter



•Optional remote controller, shall order separately.







## ■ Model No. UK-6

Height : 322 mm (w/o jaws)  
Weight : 6 kgs

## ■ Specifications:

Max. Pressure : 700 bar  
Oil Required : 92 cc  
Max Output : 6 tons / 59 kN  
Ram Stroke : 82 mm

## ■ Features:

- Self-contained Hydraulic Puller, extra hand pump, hydraulic hose and coupler are not required, easy to use and allow operating by one person.
- 2/3 jaws combination puller head as jaws can be installed with 2 or 3 jaws as changeable type against the limited space.
- Jaws proceed with forging made parts and special treatment for providing best strength and long life use.
- 360° rotary handle swivel clevis allows pumping at all directions.
- Unique safety valve designed to reduce the risk of the puller overload by limiting the applied force.
- Complete hydraulic puller allows effortless generation of force and dismounting.
- The spring-loaded centre point of the hydraulic spindle allows easy centering the puller on the shaft.

Unit : mm

Reach Range	Spread	Ram Stroke	Jaw-Tip		
165	30-200	82	A	B	C
			11.3	7.3	23

## ■ Accessories:

Plastic carrying case



• Left Spin  
(Retract)



• Right Spin  
(Advance)



# HYDRAULIC PULLER

## ■ Model No. UK-6HE



Height : 261 mm (w/o jaws)

Weight : 5.2 kgs

## ■ Specifications:

Max. Pressure : 700 bar

Oil Required : 92 cc

Max Output : 6 tons / 59 kN

Ram Stroke : 82 mm

## ■ Features:

- 2/3 jaws combination puller head as jaws can be installed with 2 or 3 jaws as changeable type against the limited space.
- Jaws proceed with forging made parts and special treatment for providing best strength and long life use.
- 360° rotary handle swivel clevis allows pumping at all directions.
- Unique safety valve designed to reduce the risk of the puller overload by limiting the applied force.
- Complete hydraulic puller allows effortless generation of force and dismounting.
- The spring-loaded centre point of the hydraulic spindle allows easy centering the puller on the shaft.
- Operated by any hydraulic pump with rated oil pressure of 700 bar (10,000 psi).

Unit : mm

Reach Range	Spread	Ram Stroke	Jaw-Tip		
165	30-200	82	A	B	C
			11.3	7.3	23

## ■ Accessories:

Plastic carrying case





## ■ Model No. UK-8

Height : 348 mm (w/o jaws)  
Weight : 8.6 kgs

## ■ Specifications:

Max. Pressure : 700 bar  
Oil Required : 134 cc  
Max Output : 8.8 tons / 86 kN  
Ram Stroke : 82 mm

## ■ Features:

- Self-contained Hydraulic Puller, extra hand pump, hydraulic hose and coupler are not required, easy to use and allow operating by one person.
- 2/3 jaws combination puller head as jaws can be installed with 2 or 3 jaws as changeable type against the limited space.
- Jaws proceed with forging made parts and special treatment for providing best strength and long life use.
- 360° rotary handle swivel clevis allows pumping at all directions.
- Unique safety valve designed to reduce the risk of the puller overload by limiting the applied force.
- Complete hydraulic puller allows effortless generation of force and dismounting.
- The spring-loaded centre point of the hydraulic spindle allows easy centering the puller on the shaft.

Unit : mm

Reach Range	Spread	Ram Stroke	Jaw-Tip		
240	30-300	82	A	B	C
			16.3	8.3	29

## ■ Accessories:

Plastic carrying case



# HYDRAULIC PULLER

## ■ Model No. UK-8HE



Height : 261 mm (w/o jaws)  
Weight : 7.8 kgs

## ■ Specifications:

Max. Pressure : 700 bar  
Oil Required : 134 cc  
Max Output : 8.8 tons / 86 kN  
Ram Stroke : 82 mm

## ■ Features:

- 2/3 jaws combination puller head as jaws can be installed with 2 or 3 jaws as changeable type against the limited space.
- Jaws proceed with forging made parts and special treatment for providing best strength and long life use.
- 360° rotary handle swivel clevis allows pumping at all directions.
- Unique safety valve designed to reduce the risk of the puller overload by limiting the applied force.
- Complete hydraulic puller allows effortless generation of force and dismounting.
- The spring-loaded centre point of the hydraulic spindle allows easy centering the puller on the shaft.
- Operated by any hydraulic pump with rated oil pressure of 700 bar (10,000 psi).

Unit : mm

Reach Range	Spread	Ram Stroke	Jaw-Tip		
240	30-300	82	A	B	C
			16.3	8.3	29

## ■ Accessories:

Plastic carrying case





## ■ Model No. UK-12

Height : 351 mm (w/o jaws)  
Weight : 9.6 kgs

## ■ Specifications:

Max. Pressure : 700 bar  
Oil Required : 190 cc  
Max Output : 12.7 tons / 125 kN  
Ram Stroke : 80 mm

## ■ Features:

- Self-contained Hydraulic Puller, extra hand pump, hydraulic hose and coupler are not required, easy to use and allow operating by one person.
- 2/3 jaws combination puller head as jaws can be installed with 2 or 3 jaws as changeable type against the limited space.
- Jaws proceed with forging made parts and special treatment for providing best strength and long life use.
- 360° rotary handle swivel clevis allows pumping at all directions.
- Unique safety valve designed to reduce the risk of the puller overload by limiting the applied force.
- Complete hydraulic puller allows effortless generation of force and dismounting.
- The spring-loaded centre point of the hydraulic spindle allows easy centering the puller on the shaft.

Unit : mm

Reach Range	Spread	Ram Stroke	Jaw-Tip		
240	50-280	80	A	B	C
			16.3	8.3	29

## ■ Accessories:

Plastic carrying case



• Left Spin  
(Retract)

• Right Spin  
(Advance)



# HYDRAULIC PULLER

## ■ Model No. UK-12HE



Height : 264 mm (w/o jaws)  
Weight : 8.8 kgs

### ■ Specifications:

Max. Pressure : 700 bar  
Oil Required : 190 cc  
Max Output : 12.7 tons / 125 kN  
Ram Stroke : 80 mm

### ■ Features:

- 2/3 jaws combination puller head as jaws can be installed with 2 or 3 jaws as changeable type against the limited space.
- Jaws proceed with forging made parts and special treatment for providing best strength and long life use.
- 360° rotary handle swivel clevis allows pumping at all directions.
- Unique safety valve designed to reduce the risk of the puller overload by limiting the applied force.
- Complete hydraulic puller allows effortless generation of force and dismounting.
- The spring-loaded centre point of the hydraulic spindle allows easy centering the puller on the shaft.
- Operated by any hydraulic pump with rated oil pressure of 700 bar (10,000 psi).

Unit : mm

Reach Range	Spread	Ram Stroke	Jaw-Tip		
240	50-280	80	A	B	C
			16.3	8.3	29

### ■ Accessories:

Plastic carrying case

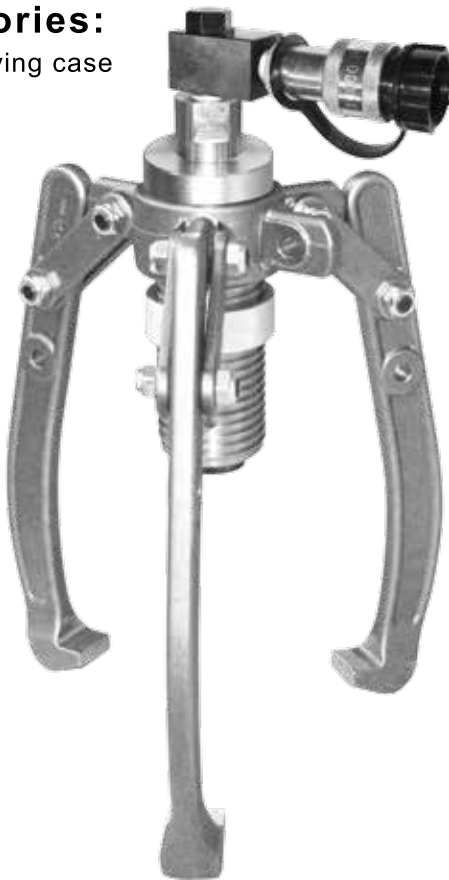



■ **Model No. UK-12L**

Height : 351 mm (w/o jaws)  
Weight : 12.4 kgs

■ **Specifications:**

Max. Pressure : 700 bar  
Oil Required : 190 cc  
Max Output : 12.7 tons / 125 kN  
Ram Stroke : 80 mm

■ **Features:**

- Self-contained Hydraulic Puller, extra hand pump, hydraulic hose and coupler are not required, easy to use and allow operating by one person.
- 2/3 jaws combination puller head as jaws can be installed with 2 or 3 jaws as changeable type against the limited space.
- Jaws proceed with forging made parts and special treatment for providing best strength and long life use.
- 360° rotary handle swivel clevis allows pumping at all directions.
- Unique safety valve designed to reduce the risk of the puller overload by limiting the applied force.
- Complete hydraulic puller allows effortless generation of force and dismounting.
- The spring-loaded centre point of the hydraulic spindle allows easy centering the puller on the shaft.

Unit : mm

Reach Range	Spread	Ram Stroke	Jaw-Tip		
275	50-360	80	A	B	C
			18.6	7.8	29

■ **Accessories:**

Plastic carrying case



# HYDRAULIC PULLER

## ■ Model No. **UK-12LHE**



Height : 264 mm (w/o jaws)

Weight : 11.6 kgs

### ■ Specifications:

Max. Pressure : 700 bar

Oil Required : 190 cc

Max Output : 12.7 tons / 125 kN

Ram Stroke : 80 mm

### ■ Features:

- 2/3 jaws combination puller head as jaws can be installed with 2 or 3 jaws as changeable type against the limited space.
- Jaws proceed with forging made parts and special treatment for providing best strength and long life use.
- 360° rotary handle swivel clevis allows pumping at all directions.
- Unique safety valve designed to reduce the risk of the puller overload by limiting the applied force.
- Complete hydraulic puller allows effortless generation of force and dismounting.
- The spring-loaded centre point of the hydraulic spindle allows easy centering the puller on the shaft.
- Operated by any hydraulic pump with rated oil pressure of 700 bar (10,000 psi).

Unit : mm

Reach Range	Spread	Ram Stroke	Jaw-Tip		
275	50-360	80	A	B	C
			18.6	7.8	29

### ■ Accessories:

Plastic carrying case





- Model No. RMHS-2M
- RMHS-3M
- RMHS-5M

■ Specifications:

- Temperature range : -20°C to +80°C
- Heavy Duty Rubber Hose



※ Without Coupler.

■ Model No. HSH38-N

■ Specification:

- Male Coupler
- 3/8" NPT
- Ball end style
- Compatible to Pioneer



■ Model No. HSH38-C

■ Specification:

- Female Coupler
- 3/8" NPT
- Ball end style
- Compatible to Pioneer



■ Model No. HSH38-ADP

■ Specification:

- Dust Cap for Male Coupler HSH38-N
- 3/8" NPT



■ Model No. HSH38-ADC

■ Specification:

- Dust Cap for Female Coupler HSH38-C
- 3/8" NPT



■ Model No. TC-372

■ Specification:

- Male Coupler
- 3/8" NPT
- Compatibly to Parker



■ Model No. TC-371

■ Specification:

- Female Coupler
- 3/8" NPT
- Compatibly to Parker



■ Model No. Nipple-3/8"

■ Specification:

- Hex Nipple
- 3/8" NPT



■ Model No. Elbow-3/8"

■ Specification:

- Connector
- 3/8" NPT



# PRESSURE TESTING EQUIPMENT

## ■ Model No. GA-001

For Testing Gauge  
• 3/8" NPT



## ■ Model No. GA-001P

Test Gauge For Pump Units:

HP-180N, HP-700A, HF-700, HYP-700FT, HP-30S,  
HP-30MD, EP-30S, EP-76MS, EP-76MD,  
EP-76SS, EP-76SD, EP-200MD, EP-200MDCF

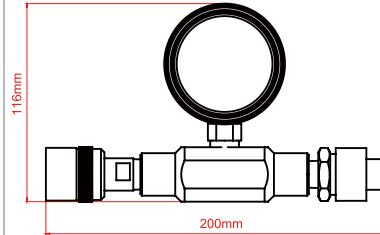

## ■ Model No. GA-185 / 240

Test Gauge For Beku Type Crimping Tool:

K-185, K-240  
LEC-185T, LEC-240T,  
HYCP-185, HYCP-240

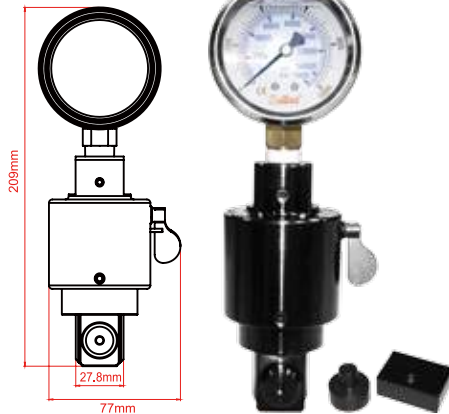

## ■ Model No. GA-PC25A



Test Gauge For Battery  
Operated Crimping Tool:

LEC-25  
K-25, K-50

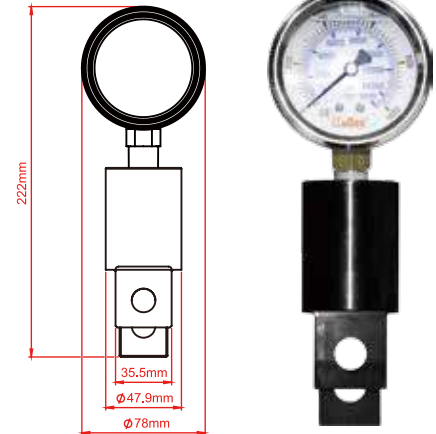

## ■ Model No. GA-12T

Test Gauge  
For Crimping Tool:

UB-400, UB-400C  
UB-412, UB-412C

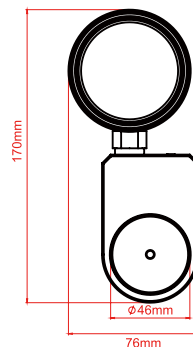

## ■ Model No. GA-13T

Test Gauge For Battery  
Operated Crimping Tool:

HEC/LEC-32,  
HEC/LEC-40,  
HEC/LEC-44,  
HYCP-4413,  
HYCP-4413C

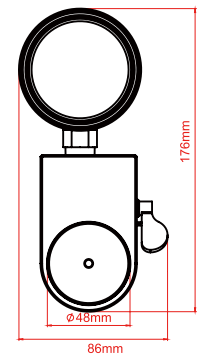

■ **Model No. Case-REC-50**

- (L) 515 mm x (W) 115 mm x (H) 324 mm

**Use for**

- REC-50



■ **Model No. Case-PN-052**

- (L) 412 mm x (W) 105 mm x (H) 297 mm

**Use for**

- PN-052
- PN-052M



■ **Model No. Case-HYNC-2432**

- (L) 412 mm x (W) 105 mm x (H) 297 mm

**Use for**

- HYNC-2432
- HYNC-2432,D
- HYNC-3241
- HYNC-3241,D



■ **Model No. Case-UB-400HE**

- (L) 412 mm x (W) 105 mm x (H) 297 mm

**Use for**

- UB-400HE
- UB-412HE
- UCP-2712HE
- H-412HE
- HYCP-4013HE
- HYCP-4413HE



■ **Model No. Case-UB-400**

- (L) 645 mm x (W) 128 mm x (H) 303 mm

**Use for**

- UB-400
- UB-400C



■ **Model No. Case-HYNC-1319**

- (L) 350 mm x (W) 86 mm x (H) 240 mm

**Use for**

- HYNC-1319
- HYNC-1924



■ **Model No. Case-HYCP-451000HE**

- (L) 560 mm x (W) 160 mm x (H) 400 mm

**Use for**

- HYCP-451000HE



■ **Model No. Case-HYCP-630HE**

- (L) 510 mm x (W) 110 mm x (H) 297 mm

**Use for**

- HYCP-630HE



# PACKAGING

## ■ Model No. Case-HYCP-15THE

- (L) 432 mm x (W) 105 mm x (H) 389 mm

### Use for

- HYCP-15THE



## ■ Model No. Case-HYCP-60ST

- (L) 480 mm x (W) 245 mm x (H) 285 mm

### Use for

- HYCP-60ST
- HYCP-60D



## ■ Model No. Case-HYCC -105HE

- (L) 662 mm x (W) 142 mm x (H) 444 mm

### Use for

- HYCC-105HE



## ■ Model No. Case-400HE

- (L) 412 mm x (W) 105 mm x (H) 297mm

### Use for

- HH-400HE
- HH-400IHE
- HH-400XLHE
- 9H-150HE
- HYCP-185HE
- HYCP-240HE
- PH-240HE
- UCP-240HE



## ■ Model No. Case-HP-700A

- (L) 820 mm x (W) 240 mm x (H) 252 mm

### Use for

- HYP-700FT
- HP-700A
- HF-700
- HP-30S
- HP-30MD



## ■ Model No. Case-REC-54/85

- (L) 515 mm x (W) 115 mm x (H) 324 mm

### Use for

- REC-54
- REC-54AC
- REC-54ACSR
- REC-65
- REC-85CCP



## ■ Model No. Case-EP-510

- (L) 765 mm x (W) 98 mm x (H) 320 mm

### Use for

- HYCP-4013
- HYCP-4413
- UCP-240
- UCP-2613



## ■ Model No. Case-HYCP-240T/PH-240

- (L) 510 mm x (W) 110mm x (H) 297 mm

### Use for

- HYCP-185
- HYCP-240
- PH-240



## ■ Model No. Case-HYCP-500HE

- (L) 355 mm x (W) 205 mm x (H) 410 mm

### Use for

- HYCP-500HE



## ■ Model No. Case-UB-412

- (L) 645 mm x (W) 128mm x (H) 303mm

### Use for

- UB-400
- UB-412
- UCP-2712



## ■ Model No. Case-400

- (L) 645 mm x (W) 128 mm x (H) 303 mm

### Use for

- HH-400I
- HH-400X
- HH-400XL
- 9H-150



## ■ Model No. Case-SH-70A

- (L) 560 mm x (W) 160 mm x (H) 400 mm

### Use for

- SH-70A



## ■ Model No. Case-HYNC-4150

- (L) 560 mm x (W) 160 mm x (H) 400 mm

### Use for

- HYNC-4150
- HYNC-5060



## ■ Model No. Case-MINI

- (L) 560 mm x (W) 160 mm x (H) 400 mm

### Use for

- K-BGD3
- K-10C
- K-185
- K-30A
- K-240
- K-50
- K-PH240
- K-150
- K-S24
- K-20
- K-24



## ■ Model No. Case-HEC/LEC-50/54/85

- (L) 560 mm x (W) 160mm x (H) 400 mm

### Use for

- LEC-50
- LEC-54
- LEC-54AC
- LEC-65
- REC-50M



## ■ Model No. Case-UC-6

- (L) 645 mm x (W) 128 mm x (H) 303 mm

### Use for

- UC-6
- UC-6FT



## ■ Model No. Case-45MX

• (L) 560 mm x (W) 160 mm x (H) 400 mm

### Use for

- LEC-24A
- LEC-25B
- LEC-85YC
- HEC-85YC



## ■ Model No. Case-UC-6HE

• (L) 412 mm x (W) 105 mm x (H) 297mm

### Use for

- UC-6FTHE
- UC-6HE



## ■ Model No. Case-SH-10

• (L) 560 mm x (W) 160mm x (H) 400 mm

### Use for

- PNST-10
- PNST-10M
- HP-180N



## ■ Model No. Case-OD3

• (L) 765 mm x (W) 98 mm x (H) 320 mm

### Use for

- HD-BGD3
- HD-OD3



## ■ Model No. Case-HEC/LEC

• (L) 560 mm x (W) 160 mm x (H) 400 mm

### Use for

- LEC-25
- LEC-U26
- HEC-240T
- HEC-S55
- LEC-185T
- LEC-6FT
- HEC-240
- HEC-C85
- LEC-240T
- LEC-6
- HEC-U27
- HEC-30A
- LEC-240
- LEC-S24
- HEC-32
- HEC-24B
- LEC-U27
- LEC-S45
- HEC-44
- HEC-S45M
- LEC-32
- LEC-S55
- HEC-44X
- HEC-C85M
- LEC-40
- LEC-C85
- HEC-6FT
- EC-14FS
- LEC-44
- LEC-30A
- HEC-6
- LEC-45X
- HEC-150
- HEC-S24
- LEC-U240
- HEC-185T
- HEC-S45



## ■ Model No. Case-KC-50/54/54AC

• (L) 560 mm x (W) 160 mm x (H) 400 mm

### Use for

- KC-50
- KC-54
- KC-54AC



## ■ Model No. Case-UK

• (L) 500 mm x (W) 320 mm x (H) 310 mm

### Use for

- UK-6
- UK-8
- UK-12
- UK-12L
- UK-6HE
- UK-8HE
- UK-12HE
- UK-12LHE



## ■ Model No. PBAG-400

- (L) 180 mm x (W) 60 mm x (H) 400 mm

### Use for

- HYSC-24
- RS-24B



## ■ Model No. PBAG-520

- (L) 70 mm x (W) 50 mm x (H) 520 mm

### Use for

- HYCC-35HE (N Brand)



## ■ Model No. CBAG-545

- (L) 545 mm x (W) 100 mm x (H) 210 mm

### Use for

- S-24
- HYSC-24
- HYCC-85YC
- YS-30A
- HYCC-050
- S-24HE
- HYSC-20HE
- HYSC-24HE
- HYSC-32HE
- HYSC-45HE
- HYSC-55HE
- S-55HE
- HYCC-050HE
- TC-085HE
- TC-120HE
- HYCC-065HE
- P-85YC
- YS-30AHE
- UC-6FTHE
- UC-6HE
- S-55HE
- PF-1319



## ■ Model No. CBAG-660

- (L) 660 mm x (W) 100 mm x (H) 240 mm

### Use for

- S-55
- HYCC-P85HE
- HYCC-075S
- HYCC-096S
- HYCC-P100HE
- TC-120HE
- TC-120HEC
- PF-2432



## ■ Model No. CBAG-760

- (L) 760 mm x (W) 105 mm x (H) 180 mm

### Use for

- HYSC-32
- HYSC-45
- HYCC-P85
- TC-085
- PC-8511
- HYCC-85YC
- FS-14



## ■ Model No. **BP-0801**

• (L) 350 mm x (W) 100 mm x (H) 500 mm

Back Bag



## ■ Model No. **SB-0801**

• (L) 350 mm x (W) 120 mm x (H) 420 mm

Shopping Bag



## ■ Model No. **MP-0801**

Mouse Pad





■ Model No. **PC-0801**

Poker Play Card



■ Model No. **GC-0801**

Golf Club



■ Model No. **GB-0801**

Golf Ball



## ■ Polo Shirt

• (3XL) 、 (2XL) 、 (XL) 、 (M) 、 (S) 、 (XS)

Size (Unit : mm)	3XL	2XL	XL	M	S	XS
Chest Perimeter	122	117	112	102	97	91
Length	75	72	72	67	65	62
Shoulder Width	48	47	46	43	41	39
Sleeve Length	28	28	27	25	24	23

※ Tolerance under  $\pm 5\%$  is acceptable.

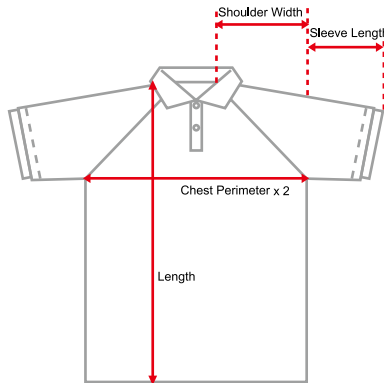

## ■ Ashtray

• (L) 157 mm x (W) 157 mm x (H) 40 mm



## ■ Diamond Mug

• (L) 73 mm x (W) 73 mm x (H) 102 mm

300 cc



APPROXIMATE CONVERSION					
		TO GET			
MULTIPLY		BY	OR	BY	TO
		MULTIPLY		GET	
SI*		CONV	NON-SI	CONV	SI*
UNIT		FACTOR	UNIT	FATCOR	UNIT
<b>LENGTH</b>					
millimeter(mm)		x0.03937	=inch	x25.4	=mm
(1 inch=25.4 mm exactly)					
centimeter (cm) 10mm		x0.3937	=inch	x2.54	=mm
meter (m) 1000mm	x3.28	=foot	x0.305	=m	
meter (m)		x1.09	=yard	x0.914	=m
kilometer(km) 1000m	x0.62	=mile	x1.61	=km	
<b>AREA</b>					
millimeter <sup>2</sup> (mm <sup>2</sup> )		x0.00155	=inch <sup>2</sup>	x645	=mm <sup>2</sup>
centimeter <sup>2</sup> (cm <sup>2</sup> )	x0.155	=inch <sup>2</sup>	x6.45	=cm	
meter <sup>2</sup> (m <sup>2</sup> )		x10.8	=foot <sup>2</sup>	x0.0929	=m <sup>2</sup>
meter <sup>2</sup> (m <sup>2</sup> )		x1.2	=yard <sup>2</sup>	x0.836	=m <sup>2</sup>
hectare (ha) 10,000m <sup>2</sup>	x2.47	=acre	x0.405	=ha	
kilometer <sup>2</sup> (km <sup>2</sup> )		x0.39	=mile <sup>2</sup>	x2.59	=km <sup>2</sup>
<b>VOLUME</b>					
centimeter <sup>3</sup> (cm <sup>3</sup> )	x0.061	=inch <sup>3</sup>	x16.4	=cm <sup>3</sup>	
liter(l)		x61	=inch <sup>3</sup>	x0.016	=l
milliliter(ml)		x0.034	=oz-liq	x29.6	=ml
(1 ml=1 cm <sup>3</sup> )					
liter (l) 1000 ml		x1.06	=quart	x0.946	=l
meter <sup>3</sup> (m <sup>3</sup> ) 1000 l	x1.3	=yard <sup>3</sup>	x0.76	=m <sup>3</sup>	
<b>MASS</b>					
gram(g)		x0.035	=ounce	x28.3	=g
kilogram(kg) 1000 g	x2.2	=pound	x0.454	=kg	
metric ton (t) 1000kg		x1.1	=ton(short)	x0.907	=t
<b>FORCE (N=kg . m/s<sup>2</sup>)</b>					
newton (N)		x0.225	=pound	x4.45	=N
kilonewton (kN)		x225	=pound	x0.00445	=kn
<b>TORQUE</b>					
newton meter (N.m)	x8.9	=lb.in.	x0.113	=N.m	
newton meter (N.m)	x0.74	=lb.ft.	x1.36	=N.m	
<b>PRESSURE(Pa =N/ m<sup>2</sup>)</b>					
kilopascal(Kpa)		x4.0	=in.H2O	x0.249	=Kpa
kilopascal(Kpa)		x0.30	=in.Hg	x3.38	=Kpa
kilopascal(Kpa)		x0.145	=p.s.i.	x6.89	=Kpa
megapascal(MPa)	x145	=p.s.i.	x0.00689	=MPa	
Bar		x14.5	=p.s.i.	x.0689	=Bar
<b>POWER (W=J/ S)</b>					
kilowatt(kw)		x1.34	=hp	x0.746	=kw
kilowatt(kw)		x0.948	=Btu/s	x1.055	=kw
watt(w)		x0.74	=ft. lb/s	x1.36	=w
<b>TEMPERATURE</b>					
°C = (°F - 32)+1.8		°F = (°C x 1.8)+32			
<b>FLOW</b>					
cu. cm/min.		x.061	=cu.in/min.	x16.4	=cu.cm/min.
liters/min.		x.2642	=GPM	x3.785	=liters/min.

\*System Intemational (Modern Metric System)

## ■ Wire Gauge

Conductor Size	Color Code	mm <sup>2</sup>	JIS	DIN
30AWG		0.05		
28AWG		0.08		
26AWG		0.13		
24AWG		0.20		
22AWG		0.32		
20AWG		0.52		
18AWG		0.81		0.9
16AWG		1.32	1.25	1.5
14AWG		2.08	2	2
12AWG		3.33		4
10AWG		5.27	5.5	6
8AWG	Red	8.30	8	10
6AWG	Blue	13.30	14	16
5AWG		16.78		
4AWG	Bray	21.09	22	25
3AWG	White	26.57		
2AWG	Brown	33.94	38	35
1AWG	Green	42.22		
1/0	Pink	53.52	60	50
2/0	Black	67.51		70
3/0	Orange	85.16	80	95
4/0	Purple	107.22	100	
250MCM	Yellow	126.68	125	120
300MCM	White	152.01	150	150
350MCM	Red	177.38		185
400MCM	Blue	202.68	200	240
500MCM	Brown	253.35	250	
600MCM	Green	304.02	325	300
700MCM		354.69		
750MCM	Black	380.03		
800MCM		405.36	400	400
900MCM		456.03		
1000MCM	White	506.70	500	500
1500MCM	Green	13.5		
1750MCM	Gray	17.5		
2000MCM	Brown	20.5		

## ■ Crimping Instruction:

•Direction of Compression: Single-sided  
Outward

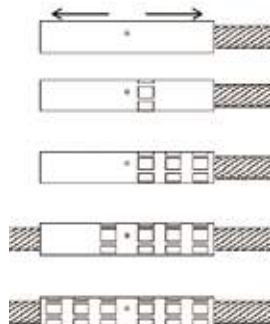

•Direction of Compression: Outward

