

Spike, Marlin
Epissoir
Pica de Marlin

Number	l mm	g	l inch	Wt. lbs.
MS-1-ST	406	916	16	2.02

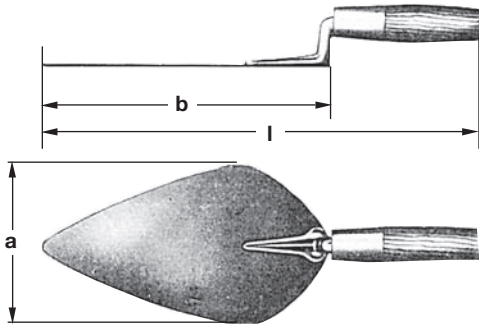

Trowel, Bricklayers'
Truelle à joints
Palustre para Ladrillos

Number	a mm	b mm	l mm	g	a inch	b inch	l inch	Wt. lbs.
T-10	130	215	335	475	5 ¹ / ₈	8 ¹ / ₂	13 ³ / ₄	1.04
T-12	140	280	360	615	5 ¹ / ₂	11	14 ¹ / ₄	1.36

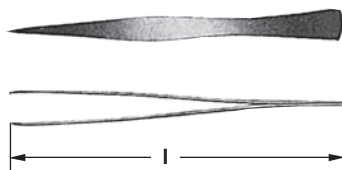

Tweezer
Pincette
Pinzeta

Number	l mm	g	l inch	Wt. lbs.
8340	110	10	4 ¹ / ₄	.02



Wedge, Flange
Coin (casse joint)
Cuña de Pestaña

Number	a mm	b mm	l mm	g	a inch	b inch	l inch	Wt. lbs.
W-1	6	15	80	50	1/4	1/2	3	.04
W-2	13	19	102	100	1/2	3/4	4	.18
W-3	13	25	150	200	1/2	1	6	.42
W-4	19	38	150	400	3/4	1 1/2	6	.92
W-5	13	32	180	300	1/2	1 1/4	7	.64
W-6	19	50	180	700	3/4	2	7	1.56
W-7	41	38	200	1300	1 5/8	1 1/2	8	2.50
W-8	25	38	200	800	1	1 1/2	8	1.72
W-9	19	50	200	700	3/4	2	8	1.66
W-10	32	50	215	1400	1 1/4	2	8 1/2	2.96
W-11	10	50	180	400	3/8	2	7	.74
W-12	10	50	90	200	3/8	2	3 1/2	.40



Wedge, Stone
Coin à pierre
Cuña de Piedra

Number	a mm	l mm	g	a inch	l inch	Wt. lbs.
7960	44	120	1100	1 1/2	4 3/4	2.43
7962	45	150	1400	1 1/2	6	3.09
7964	47	190	2000	1 3/4	7 1/2	4.41
7966	50	240	3000	2	9 1/2	6.62

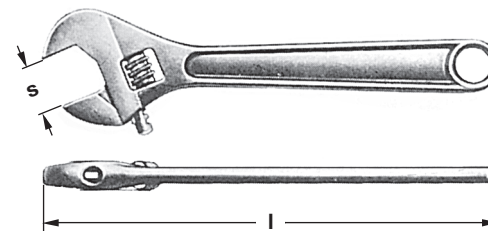

Wrench, Adjustable End
Clé à molette
Llave de Cabeza Ajustable

Number	s max mm	l mm	g	s max inch	l inch	Wt. lbs.
W-70	24	152	100	15/16	6	.22
W-71	29	203	200	1 1/8	8	.44
W-72	33	254	313	1 5/16	10	.69
W-73	38	305	567	1 1/2	12	1.25
W-74	43	381	1275	1 11/16	15	2.81

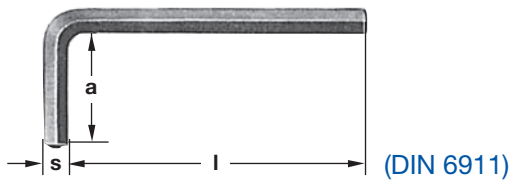

(DIN 6911)

Wrench, Allen/Hex Key
Clé male pour vis creuse à 6 pans
Llave Allen

Millimeter (mm)				
Part Number	s mm	a mm	l mm	⚖ g
WH-1.5	1.5	20	63	2
WH-2	2	20	63	2
WH-2.5	2.5	20	63	4
WH-3	3	20	63	5
WH-4	4	25	70	11
WH-5	5	28	79	19
WH-6	6	32	90	30
WH-7	7	35	95	45
WH-8	8	36	100	60
WH-9	9	38	106	83
WH-10	10	40	112	105
WH-11	11	41	119	138
WH-12	12	44	125	170
WH-13	13	51	135	215
WH-14	14	57	140	260
WH-17	17	63	159	444
WH-19	19	70	179	618
WH-22	22	80	198	950
WH-24	24	89	222	1260
WH-27	27	100	249	1780
WH-30	30	113	279	2460
WH-32	32	125	318	3140
WH-36	36	140	356	4470
American Inch (")				
Number	s inch	a inch	l inch	Wt. lbs.
WH-1/16	1/16	3/4	1 3/4	.01
WH-5/64	5/64	3/4	1 3/4	.02
WH-3/32	3/32	3/4	1 7/8	.02
WH-1/8	1/8	13/16	2 5/16	.02
WH-5/32	5/32	7/8	2 1/2	.02
WH-3/16	3/16	7/8	2 7/8	.04
WH-7/32	7/32	1 1/16	3 1/8	.06
WH-1/4	1/4	1 1/16	3 7/8	.08
WH-5/16	5/16	1 3/8	4 1/8	.14
WH-3/8	3/8	1 1/2	4 1/2	.24
WH-7/16	7/16	1 3/4	5 1/4	.36
WH-1/2	1/2	1 3/4	5 1/4	.46
WH-9/16	9/16	1 3/4	5 3/4	.62
WH-5/8	5/8	1 7/8	6 1/4	.86
WH-11/16	11/16	2 1/4	7 1/4	1.20
WH-3/4	3/4	2 1/4	7 1/4	1.42
WH-7/8	7/8	2 1/4	7 1/4	1.98
WH-1	1	2 1/4	7 1/4	2.60

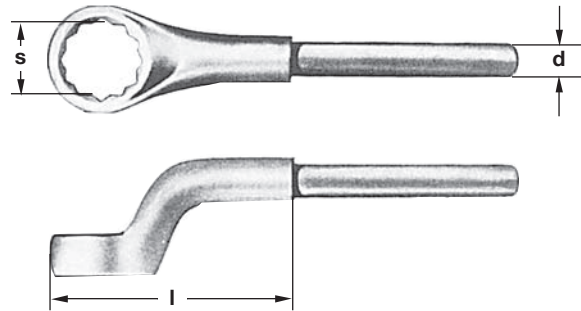

Wrench, Box, For Extension
Clé polygonale à traction
Llave de Cajón Para Extensión

Millimeter (mm)				
Number	s mm	l mm	d mm	⚖ g
4800	30	117	21,3	800
4802	32	117	21,3	800
4804	33	117	21,3	800
4806	34	117	21,3	800
4808	35	127	21,3	850
4810	36	127	21,3	850
4812	37	132	21,3	950
4814	38	132	21,3	950
4816	41	139	21,3	1000
4818	42	139	21,3	1000
4820	46	158	24,3	1400
4822	47	158	24,3	1400
4824	50	164	24,3	1550
4826	52	164	24,3	1550
4828	54	164	24,3	1550
4830	55	168	24,3	1650
4832	56	168	24,3	1650
4834	58	168	24,3	1650
4836	60	188	29,3	2450
4838	63	188	29,3	2450
4840	65	196	29,3	2700
4842	67	196	29,3	2700
4844	70	202	29,3	2850
4846	71	202	29,3	2850
4848	75	210	29,3	3200
4850	77	210	29,3	3200
4852	80	215	29,3	3600
4854	82	215	29,3	3600
4856	85	215	29,3	3600
American Inch (")				
Number	s mm	l inch	d inch	Wt. lbs.
4950	1 3/16	4 1/2	4/5	1.76
4952	1 1/4	4 1/2	4/5	1.76
4954	1 5/16	4 1/2	4/5	1.76
4956	1 3/8	5	4/5	1.87

Number	s mm	l inch	d inch	Wt. lbs.
4958	1 ⁷ / ₁₆	5	⁴ / ₅	1.87
4960	1 ¹ / ₂	5 ¹ / ₄	⁴ / ₅	2.09
4962	1 ⁹ / ₁₆	5 ¹ / ₂	⁴ / ₅	2.21
4964	1 ⁵ / ₈	5 ¹ / ₂	⁴ / ₅	2.21
4966	1 ¹¹ / ₁₆	5 ¹ / ₂	⁴ / ₅	2.21
4968	1 ³ / ₄	5 ¹ / ₂	⁴ / ₅	2.21
4970	1 ¹³ / ₁₆	6 ¹ / ₄	1	3.09
4972	1 ⁷ / ₈	6 ¹ / ₄	1	3.09
4974	2	6 ¹ / ₂	1	3.42
4976	2 ¹ / ₁₆	6 ¹ / ₂	1	3.42
4978	2 ¹ / ₈	6 ¹ / ₂	1	3.42
4980	2 ³ / ₁₆	6 ³ / ₄	1	3.64
4982	2 ¹ / ₄	6 ³ / ₄	1	3.64
4984	2 ⁵ / ₁₆	6 ³ / ₄	1	3.64
4986	2 ³ / ₈	7 ¹ / ₄	1	5.40
4988	2 ⁷ / ₁₆	7 ¹ / ₄	1	5.40
4990	2 ¹ / ₂	7 ¹ / ₄	1	5.40
4992	2 ⁹ / ₁₆	7 ³ / ₄	1 ¹ / ₄	5.95
4994	2 ⁵ / ₈	7 ³ / ₄	1 ¹ / ₄	5.95
4996	2 ³ / ₄	8	1 ¹ / ₄	6.28
4998	2 ¹³ / ₁₆	8	1 ¹ / ₄	6.28
5000	2 ¹⁵ / ₁₆	8	1 ¹ / ₄	6.28
5002	3	8 ¹ / ₄	1 ¹ / ₄	7.06
5004	3 ¹ / ₈	8 ¹ / ₂	1 ¹ / ₄	7.94
5006	3 ¹ / ₄	8 ¹ / ₂	1 ¹ / ₄	7.94
5008	3 ³ / ₈	8 ¹ / ₂	1 ¹ / ₄	7.94

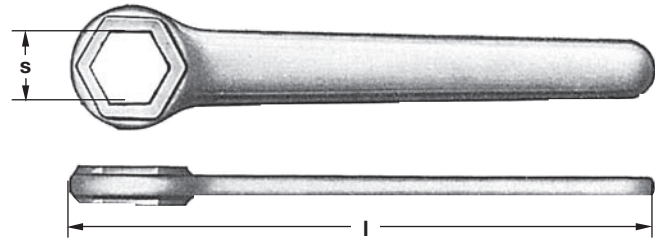

Wrench, Box End, 6-point

Clé fermée, 6 pans

Llave de Cajón Sencilla, 6-puntos

Millimeter (mm)			
Number	s mm	l mm	Δ g
4000	12	130	50
4002	13	130	50
4004	14	165	100
4006	15	165	100
4008	16	165	100
4010	17	165	100
4012	18	165	100
4014	19	205	200
4016	20	205	200
4018	21	205	200
4020	22	205	200
4022	23	205	200
4024	24	240	400
4026	25	240	400
4028	26	240	400
4030	27	240	400
4032	28	240	400
4034	29	270	500
4036	30	270	500
4038	32	270	500
4040	33	270	500
4042	34	270	500
4044	35	310	1100
4046	36	310	1100
4048	37	310	1100
4050	38	310	1100
4052	41	375	1150
4054	42	375	1150
4056	46	410	1650
4058	47	410	1650
4060	50	445	2100
4062	52	445	2100
4064	54	470	2900
4066	55	470	2900
4068	56	470	2900
4070	58	525	3200
4072	60	525	3200
4074	63	525	3200
4076	65	580	4200
4078	67	580	4200

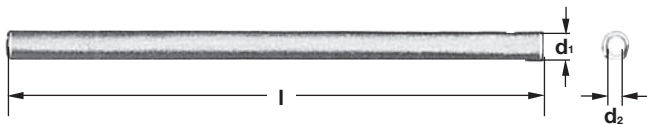

Extension For Box Wrench

Tube levier pour clé polygonale

Extensión Para la Llave de Cajón

Number	d ₁ mm	d ₂ mm	l mm	Δ g	d ₁ inch	d ₂ inch	l inch	Wt. lbs.
5050	26	22	600	800	1	³ / ₄	23 ¹ / ₂	1.76
5054	30	25	750	1450	1 ¹ / ₄	1	29 ¹ / ₂	3.20
5058	36	30	850	2250	1 ¹ / ₂	1 ¹ / ₄	33 ¹ / ₂	4.96

Number	s mm	l mm	⚖ g
4080	70	600	4500
4082	71	600	4500
4084	75	620	5500
4086	77	620	5500
4088	80	650	7000

American Inch (")

Number	s inch	l inch	Wt. lbs.
4200	1/2	5	0.11
4202	9/16	6 1/2	0.22
4204	19/32	6 1/2	0.22
4206	5/8	6 1/2	0.22
4208	11/16	6 1/2	0.22
4210	3/4	8	0.44
4212	25/32	8	0.44
4214	13/16	8	0.44
4216	7/8	8	0.44
4218	15/16	9 1/2	0.88
4220	31/32	9 1/2	0.88
4222	1	9 1/2	0.88
4224	1 1/16	9 1/2	0.88
4226	1 1/8	9 1/2	0.88
4228	1 3/16	10 1/2	1.10
4230	1 1/4	10 1/2	1.10
4232	1 5/16	10 1/2	1.10
4234	1 3/8	12 1/4	2.43
4236	1 7/16	12 1/4	2.43
4238	1 1/2	12 1/4	2.43
4240	1 9/16	12 1/4	2.43
4242	1 5/8	14 3/4	2.54
4244	1 11/16	14 3/4	2.54
4246	1 3/4	16	3.64
4248	1 13/16	16	3.64
4250	1 7/8	16	3.64
4252	2	17 1/2	4.63
4254	2 1/16	17 1/2	4.63
4256	2 1/8	17 1/2	4.63
4258	2 3/16	18 1/2	6.39
4260	2 1/4	18 1/2	6.39
4262	2 5/16	20 1/2	7.06
4264	2 3/8	20 1/2	7.06
4266	2 7/16	20 1/2	7.06
4268	2 1/2	20 1/2	7.06
4270	2 9/16	22 3/4	9.26



Wrench, Box End, 12-Point (DIN 3111)
Clé fermée, 12 pans
Llave de Cajañ Sencilla, 12-Puntos

Millimeter (mm)			
Number	s mm	l mm	⚖ g
4400	14	138	65
4402	15	138	65
4404	16	155	90
4406	17	155	90
4408	18	171	125
4410	19	171	125
4412	20	171	125
4414	21	190	160
4416	22	190	160
4418	23	190	160
4420	24	215	250
4422	25	215	250
4424	26	215	250
4426	27	230	280
4428	28	230	280
4430	29	230	280
4432	30	254	370
4434	32	265	400
4436	33	265	400
4438	34	295	610
4440	35	295	610
4442	36	295	610
4444	37	295	610
4446	38	295	610
4448	41	330	750
4450	42	330	750
4452	46	365	1050
4454	47	365	1050
4456	50	400	1400
4458	52	400	1400
4460	54	400	1400
4462	55	442	1700
4464	56	442	1700
4466	58	442	1700
4468	60	475	1900
4470	63	475	1900
4472	65	510	2300
4474	67	510	2300
4476	70	555	2900
4478	71	555	2900
4480	75	590	3050

Number	s mm	l mm	Δ g
4482	77	590	3050
4484	80	620	4700
4486	82	620	4700
4488	85	665	4900
4490	88	665	4900
4492	90	700	5800
4494	94	700	5800
4496	95	700	5800

American Inch (")			
Number	s inch	l inch	Wt. lbs.
4600	1/2	5 1/4	0.14
4602	9/16	5 1/4	0.14
4604	19/32	5 1/4	0.14
4606	5/8	6	0.20
4608	11/16	6	0.20
4610	3/4	6 3/4	0.28
4612	25/32	6 3/4	0.28
4614	13/16	7 1/2	0.35
4616	7/8	7 1/2	0.35
4618	15/16	8 1/2	0.55
4620	31/32	8 1/2	0.55
4622	1	8 1/2	0.55
4624	1 1/16	9	0.62
4626	1 1/8	9	0.62
4628	1 3/16	10	0.82
4630	1 1/4	10 1/2	0.88
4632	1 5/16	11 1/2	1.35
4634	1 3/8	11 1/2	1.35
4636	1 7/16	11 1/2	1.35
4638	1 1/2	11 1/2	1.35
4640	1 9/16	13	1.65
4642	1 5/8	13	1.65
4644	1 11/16	13	1.65
4646	1 3/4	14 1/4	2.32
4648	1 13/16	14 1/4	2.32
4650	1 7/8	14 1/4	2.32
4652	2	15 3/4	3.09
4654	2 1/16	15 3/4	3.09
4656	2 1/8	17 1/4	3.75
4658	2 3/16	17 1/4	3.75
4660	2 1/4	17 1/4	3.75
4662	2 5/16	18 3/4	4.19
4664	2 3/8	18 3/4	4.19
4666	2 7/16	18 3/4	4.19
4668	2 1/2	20	4.19
4670	2 9/16	20	5.07
4672	2 3/4	21 3/4	6.39
4674	2 15/16	23 1/4	6.73
4676	3	23 1/4	6.73
4678	3 1/8	24 1/2	10.36
4680	3 3/8	26	10.36
4682	3 1/2	27 1/2	12.79
4684	3 3/4	27 1/2	12.79

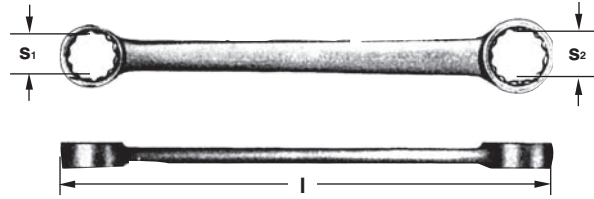

Wrench, Box End, Double, Straight Type, 12-Point
Clé polygonale double droite, 12 pans
Llave de Cajón Doble, Tipo Recto, 12-Puntos

Millimeter (mm)			
Number	s1 x s2 mm	l mm	Δ g
0800	6 x 7	100	12
0802	8 x 10	125	30
0804	9 x 11	133	45
0806	12 x 14	155	60
0808	13 x 15	170	90
0810	14 x 17	170	90
0812	16 x 18	190	125
0814	17 x 19	190	125
0816	19 x 22	215	195
0818	21 x 23	235	215
0820	24 x 27	270	280
0822	26 x 28	295	370
0824	30 x 32	330	450

American Inch (")			
Number	s1 x s2 inch	l inch	Wt. lbs.
0860	1/4 X 5/16	4	0.02
0862	5/16 X 3/8	5	0.07
0864	3/8 X 7/16	5 1/4	0.10
0866	7/16 X 9/16	6	0.13
0868	1/2 X 5/8	6 1/2	0.20
0870	1/2 X 19/32	6 1/2	0.20
0872	9/16 X 11/16	6 1/2	0.20
0874	5/8 X 25/32	7 1/2	0.28
0876	11/16 X 3/4	7 1/2	0.28
0878	3/4 X 7/8	8 1/2	0.43
0880	13/16 X 15/16	9 1/4	0.47
0882	15/16 X 1 1/16	10 1/2	0.62
0884	1 X 1 1/8	11 1/2	0.82
0886	1 3/16 X 1 1/4	13	0.99

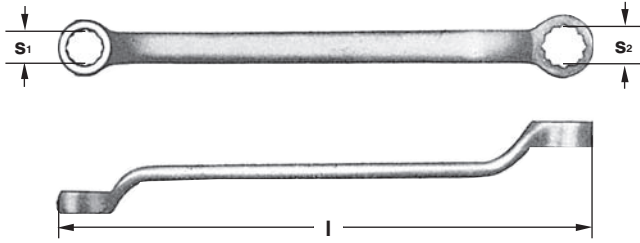

Wrench, Box End, Double, Offset Type, 12-Point
Clé polygonale double, contre-coudée, 12 pans
Llave de Cajón Doble, Tipo Acodado, 12-Puntos

Millimeter (mm)			
Number	s1 x s2 mm	l mm	g
1000	6 x 7	155	40
1002	7 x 9	155	40
1004	8 x 9	155	40
1006	8 x 10	170	77
1008	9 x 11	170	77
1010	10 x 11	170	77
1012	10 x 12	180	105
1014	11 x 12	180	105
1016	12 x 13	180	105
1018	10 x 14	200	130
1020	11 x 14	200	130
1022	12 x 14	200	130
1024	13 x 15	220	180
1026	14 x 15	220	180
1028	14 x 17	230	200
1030	16 x 17	260	255
1032	16 x 18	260	255
1034	17 x 19	280	300
1036	18 x 19	280	300
1038	17 x 22	330	420
1040	19 x 22	330	420
1042	19 x 24	330	420
1044	20 x 22	330	420
1046	21 x 23	330	420
1048	22 x 24	360	560
1050	24 x 26	360	560
1052	22 x 27	400	660
1054	24 x 27	400	660
1056	25 x 28	400	660
1058	24 x 30	410	820
1060	27 x 30	410	820
1062	27 x 32	410	820
1064	30 x 32	430	820
1066	30 x 36	480	1350
1068	32 x 36	480	1350
1070	36 x 41	510	1750
1072	41 x 46	580	2550
1074	46 x 50	630	3300
1076	50 x 55	690	4250
1078	50 x 60	740	4250

Number	s mm	l mm	g
1080	55 x 60	740	5300
1082	65 x 70	760	7600
1084	70 x 75	780	9400

American Inch (")			
Number	s1 x s2 inch	l inch	Wt. lbs.
W-3109	5/16 x 3/8	7 3/4	0.12
W-3110	3/8 x 7/16	7 3/4	0.22
W-3120	7/16 x 1/2	7 3/4	0.22
W-3130	1/2 x 9/16	9 1/2	0.26
W-3140	1/2 x 19/32	9 1/2	0.44
W-3150	9/16 x 5/8	9 1/2	0.40
W-3160	5/8 x 3/4	10 3/4	0.46
W-3170	11/16 x 25/32	10 3/4	0.66
W-3180	3/4 x 7/8	12 1/4	0.74
W-3190	13/16 x 7/8	12 1/4	0.72
W-3210	7/8 x 1	14 3/4	1.20
W-3220	7/8 x 1 1/16	15 5/8	1.48
W-3221	15/16 x 1	14 3/4	1.24
W-3230	15/16 x 1 1/16	15 5/8	1.42
W-3240	1 x 1 1/8	15 5/8	1.36
W-3241	1 1/16 x 1 1/8	15 5/8	1.32
W-3250	1 1/16 x 1 1/4	19 1/4	2.42
W-3260	1 1/8 x 1 5/16	19 1/4	2.34
W-3261	1 1/4 x 1 5/16	19 1/4	2.28
W-3270	1 1/4 x 1 7/16	19 1/4	2.26
W-3271	1 7/16 x 1 5/8	19 1/4	2.66

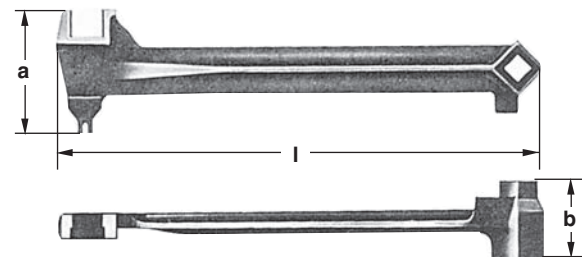

Wrench, Bung, for 22 different bungs
Clé universelle, pour débouder les fûts
Llave Taponadora para 22 Tapones Diferentes

Number	a mm	b mm	l mm	g	a inch	b inch	l inch	Wt. lbs.
W-58-S	65	60	385	1300	2 1/2	2 1/4	15	2.70

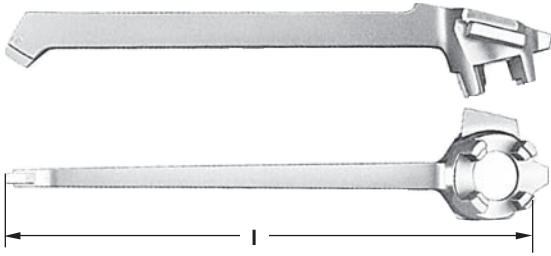

Wrench, Bung, fits 3/4" & 2" bungs
Clé à boudes
Llave Taponadora

Number	l mm	Δ g	l inch	Wt. lbs.
W-56	305	680	12	1.50

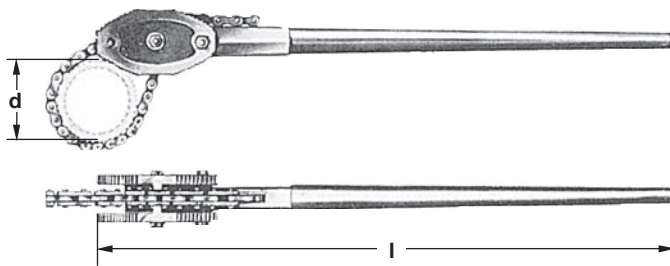

Wrench, Chain Pipe
Serre-tube à chaîne
Llave Encadenadora de Tubos

Number	d max mm	l mm	Δ g	d max inch	l inch	Wt. lbs.
W-60	38	508	2650	1½	20	5.72
W-61	65	685	4500	2½	27	9.44
W-62	305	1830	30730	12	72	67.74
W-63	100	915	12710	4	36	28.02

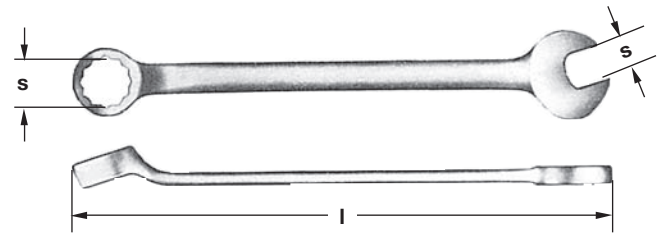

Wrench, Combination
Clé mixte
Llave Combinada

Millimeter (mm)			
Number	s mm	l mm	Δ g
1300	8	135	45
1302	9	150	50
1304	10	160	50
1306	11	175	75
1308	12	190	95
1310	13	205	115
1312	14	205	115
1314	15	225	145
1316	16	225	145
1318	17	245	170
1320	18	245	170
1322	19	270	260
1324	20	270	260
1326	21	295	300
1328	22	295	300
1330	23	325	400
1332	24	325	400
1334	25	355	550
1336	26	355	550
1338	27	355	550
1340	28	390	690
1342	30	390	690
1344	32	430	1000
1346	34	430	1000
1348	36	475	1100
1350	38	475	1100
1352	41	525	1450
1354	46	575	1900
1356	50	575	2200
1358	55	575	2600
1360	60	575	3150
1362	65	575	4580
1364	70	575	4580

American Inch (")			
Number	s inch	l inch	Wt. lbs.
W-601	3/8	6 5/16	0.16
W-601A	13/32	6 5/16	0.16

Number	s inch	l inch	Wt. lbs.
W-611	7/16	7 1/4	0.16
W-621	1/2	7 1/4	0.14
W-631	9/16	8 1/4	0.26
W-632	19/32	8 1/16	0.25
W-641	5/8	8 7/8	0.33
W-651	11/16	10 1/8	0.46
W-661	3/4	10 1/8	0.46
W-662	25/32	10 5/8	0.46
W-670	13/16	11 5/8	0.63
W-671	7/8	13 1/4	0.94
W-671b	15/16	13 1/4	0.90
W-670a	31/32	12 13/16	0.90
W-671a	1	13 1/4	0.90
W-672	1 1/16	17	1.22
W-673	1 1/8	17	1.26
W-673a	1 3/16	15 3/8	1.4
W-674	1 1/4	19 1/2	2.08
W-675	1 5/16	16 15/16	2.46
W-676	1 3/8	21 1/4	2.84
W-677	1 7/16	21 1/4	2.78
W-678	1 1/2	22	3.38
W-678a	1 9/16	18 11/16	2.17
W-679	1 5/8	22	3.30
1504	1 11/16	22 3/4	4.19
1506	1 3/4	22 3/4	4.19
1508	2	22 3/4	4.85
1510	2 3/16	22 3/4	5.73
1512	2 3/8	22 3/4	6.94
1514	2 9/16	22 3/4	10.08
1516	2 3/4	22 3/4	10.08
1518	2 5/8	22 3/4	10.08

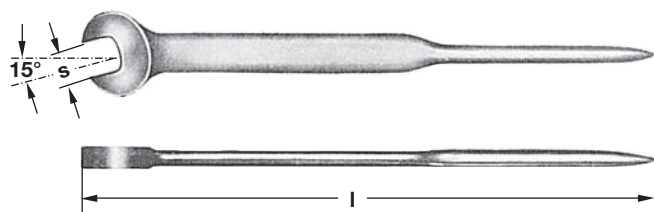

Wrench, Construction, with Pin
Clé à broche, avec pointe
Llave de Construcción con Perno

Millimeter (mm)			
Number	s mm	l mm	Wt. g
3400	17	320	270
3402	18	320	270
3404	19	350	465
3406	20	350	465
3408	21	350	465

Number	s mm	l mm	Wt. g
3411	22	350	465
3412	23	370	650
3414	24	370	650
3416	25	370	650
3418	26	370	650
3420	27	370	650
3422	28	400	950
3424	29	400	950
3426	30	400	950
3428	32	400	950
3430	33	400	950
3432	34	400	950
3434	35	430	1400
3436	36	430	1400
3438	37	430	1400
3440	38	430	1400
3442	41	470	1900
3444	42	470	1900
3446	46	500	2700
3448	47	500	2700
3450	50	530	3550

American Inch (")			
Number	s inch	l inch	Wt. lbs.
3550	1 1/16	12 1/2	0.60
3552	3/4	13 3/4	1.03
3554	25/32	13 3/4	1.03
3556	13/16	13 3/4	1.03
3558	7/8	13 3/4	1.03
3560	15/16	14 1/2	1.43
3562	31/32	14 1/2	1.43
3564	1	14 1/2	1.43
3566	1 1/16	14 1/2	1.43
3568	1 1/8	15 3/4	2.09
3570	1 3/16	15 3/4	2.09
3572	1 1/4	15 3/4	2.09
3574	1 5/16	15 3/4	2.09
3576	1 3/8	17	3.09
3578	1 7/16	17	3.09
3580	1 1/2	17	3.09
3582	1 9/16	18 1/2	4.19
3584	1 5/8	18 1/2	4.19
3586	1 11/16	18 1/2	4.19
3588	1 3/4	19 3/4	5.95
3590	1 13/16	19 3/4	5.95
3592	1 7/8	19 3/4	5.95
3594	2	20 3/4	7.83



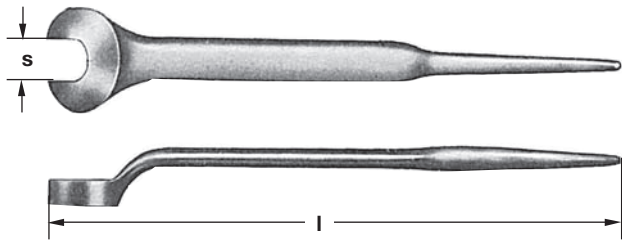

Wrench, Construction, Offset Type with Pin
Clé à broche, coudée tête droite
Llave de Construcción, Tipo Acodada con Perno

Millimeter (mm)			
Number	s mm	l mm	△ g
3700	17	320	295
3702	18	320	295
3704	19	350	510
3706	20	350	510
3708	21	350	510
3710	22	350	510
3712	23	370	715
3714	24	370	715
3716	25	370	715
3718	26	370	715
3720	27	370	715
3722	28	400	1145
3724	29	400	1145
3726	30	400	1145
3728	32	400	1145
3730	33	400	1145
3732	34	400	1145
3734	35	430	1540
3736	36	430	1540
3738	37	430	1540
3740	38	430	1540
3742	41	470	2090
3744	42	470	2090
3746	46	500	2970
3748	47	500	2970
3750	50	530	3900
American Inch (")			
Number	s inch	l inch	Wt. lbs.
W-219	1 ¹ / ₁₆	11 ¹ / ₂	0.50
W-220	7 ⁷ / ₈	14	1.28
W-221	1 ¹ / ₁₆	15	1.68
W-222	1 ¹ / ₄	15	1.68
W-223	1 ⁷ / ₁₆	18	4.38
W-224	1 ⁵ / ₈	20	5.84
W-225	1 ¹³ / ₁₆	21 ¹ / ₂	6.94
W-226	2	21 ¹ / ₂	6.58

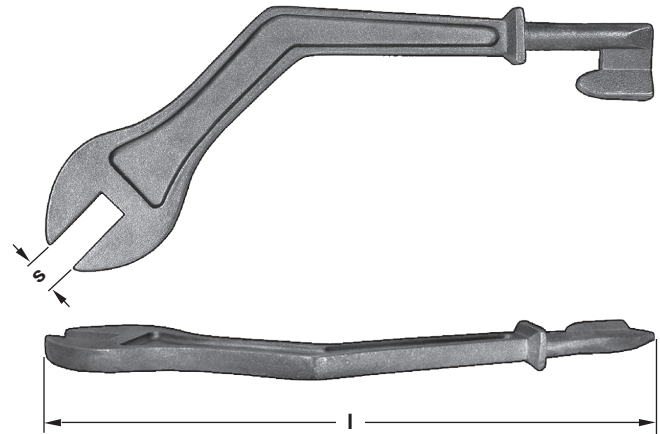

Wrench, Gas & Water Shut-off
Clé pour eau / gas
Llave para agua / gas

Number	s mm	l mm	△ g	s inch	l inch	Wt. lbs.
W-20	13	292	400	1/2	11 ¹ / ₂	.88

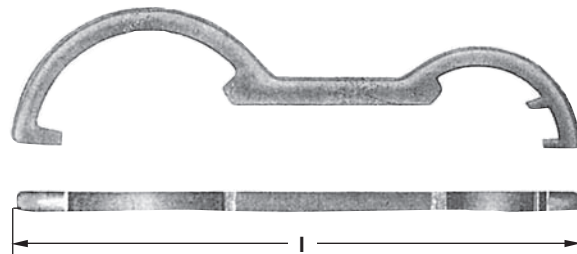

Wrench, Hose Coupling, A-B-C (DIN 14822)
Clé pour raccord de tuyau, A-B-C
Llave de Ansas Acopladas, A-B-C

Number	l mm	△ g	l inch	Wt. lbs.
7462	455	1100	18	2.43

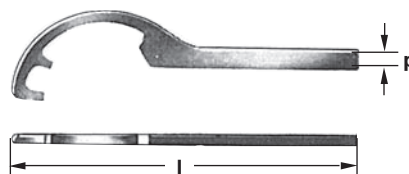

Wrench, Hose Coupling, B-C
Clé pour raccord de tuyau, B-C
Llave de Ansas Acopladas, B-C

Number	p mm	l mm	△ g	p inch	l inch	Wt. lbs.
7460	12	285	460	1/2	11 ¹ / ₄	1.01

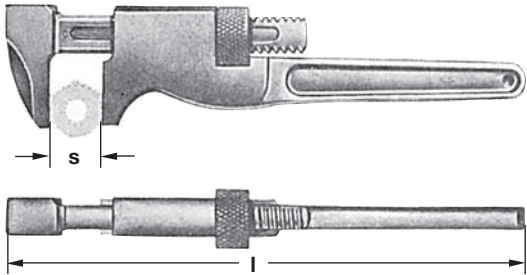

Wrench, Monkey (Railroad)
Clé anglaise (chemin de fer)
Llave Inglesa (Ferrocarril)

Number	s max mm	l mm	△ g	s max inch	l inch	Wt. lbs.
W-1145	38	203	670	1½	8	1.48
W-1146	48	254	980	1⅞	10	2.16
W-1147	58	305	1605	2¼	12	3.54
W-1148	70	380	2370	2⅓ ₁₆	15	5.22
W-1149	80	460	3855	3	18	8.50
W-1150	105	540	5090	4⅛	21	11.22

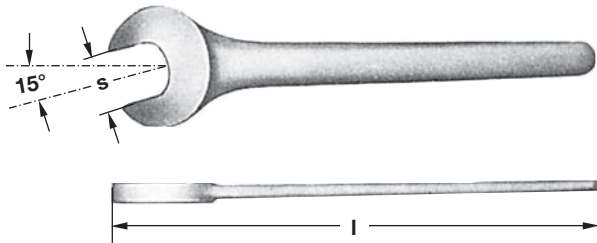

Wrench, Open End
Clé à fourche simple
Llave de Boca Sencilla

Millimeter (mm)			
Number	s mm	l mm	△ g
0102	8	100	28
0104	9	110	30
0106	10	115	35
0108	11	125	45
0110	12	135	55
0112	13	145	70
0114	14	145	70
0116	15	155	90

Number	s mm	l mm	△ g
0118	16	155	90
0120	17	170	115
0122	18	170	115
0124	19	185	155
0126	20	185	155
0128	21	200	180
0130	22	200	180
0132	23	220	250
0134	24	220	250
0136	25	240	350
0138	26	240	350
0140	27	240	350
0142	28	260	420
0144	29	260	420
0146	30	260	420
0148	32	285	550
0150	33	285	550
0152	34	285	550
0154	35	310	710
0156	36	310	710
0158	37	310	710
0160	38	310	710
0162	41	340	980
0164	42	340	980
0166	46	375	1160
0168	47	375	1160
0170	50	415	1660
0172	52	415	1660
0174	54	455	2210
0176	55	455	2210
0178	56	455	2210
0180	58	505	2940
0182	60	505	2940
0184	63	555	4000
0186	65	555	4000
0188	67	555	4000
0190	70	555	4000
0192	71	615	4800
0194	75	615	4800
0196	77	615	4800
0198	80	615	4800
0200	82	615	4800
0202	85	690	6250
0204	88	690	6250
0206	90	690	6250
0208	94	770	8300
0210	95	770	8300
0212	100	770	8300

American Inch (")			
Number	s inch	l inch	Wt. lbs.
0250	5/16	4	0.07
0252	11/32	4	0.07

Number	s inch	l inch	Wt. lbs.
0254	3/8	4 1/2	0.08
0256	13/32	4 1/2	0.08
0258	7/16	5	0.10
0260	1/2	5 1/4	0.12
0262	9/16	5 3/4	0.15
0264	19/32	6	0.20
0266	5/8	6	0.20
0268	11/16	6 3/4	0.25
0270	3/4	7 1/2	0.34
0272	25/32	7 1/2	0.34
0274	13/16	7 3/4	0.40
0276	7/8	7 3/4	0.40
0278	15/16	8 1/2	0.55
0280	31/32	8 1/2	0.55
0282	1	9 1/2	0.77
0284	1 1/16	9 1/2	0.77
0286	1 1/8	10 1/4	0.93
0288	1 3/16	10 1/4	0.93
0290	1 1/4	11 1/4	1.21
0292	1 5/16	11 1/4	1.21
0294	1 3/8	12 1/4	1.57
0296	1 7/16	12 1/4	1.57
0298	1 1/2	12 1/4	1.57
0300	1 9/16	13 1/4	1.57
0302	1 5/8	13 1/4	2.16
0304	1 11/16	14 3/4	2.56
0306	1 3/4	14 3/4	2.56
0308	1 13/16	14 3/4	2.56
0310	1 7/8	16 1/4	3.66
0312	2	16 1/4	3.66
0314	2 1/16	18	4.65
0316	2 1/8	18	4.65
0318	2 3/16	18	4.65
0320	2 1/4	18	4.65
0322	2 5/16	20	4.65
0324	2 3/8	20	6.48
0326	2 7/16	20	6.48
0328	2 1/2	21 3/4	8.82
0330	2 9/16	21 3/4	8.82
0332	2 5/8	21 3/4	8.82
0334	2 3/4	21 3/4	8.82
0336	2 13/16	24 1/4	10.58
0338	2 15/16	24 1/4	10.58
0340	3	24 1/4	10.58
0342	3 1/8	24 1/4	10.58
0344	3 1/4	24 1/4	10.58
0346	3 3/8	27	13.78
0348	3 1/2	27	13.78
0350	3 5/8	30 1/4	18.30
0352	3 3/4	30 1/4	18.30
0354	3 7/8	30 1/4	18.30

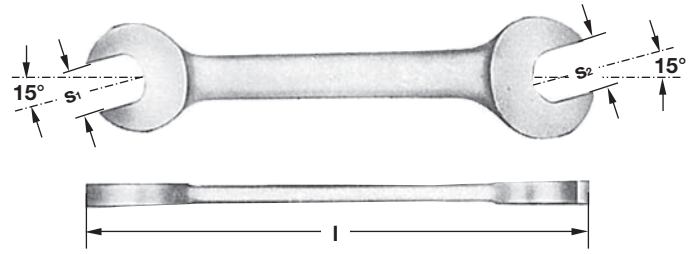

Wrench, Open End, Double
Clé à fourche double
Llave de Boca Doble

Millimeter (mm)			
Number	s1 x s2 mm	l mm	g
0451	6 x 7	95	25
0452	6 x 8	100	30
0454	7 x 8	100	30
0456	7 x 9	110	35
0458	8 x 9	110	35
0460	8 x 10	115	40
0462	9 x 10	115	40
0464	9 x 11	125	50
0470	11 x 13	145	85
0472	11 x 14	145	85
0474	12 x 14	145	85
0476	13 x 15	155	105
0478	14 x 16	155	105
0480	14 x 17	170	130
0482	16 x 18	170	130
0484	17 x 19	185	165
0486	18 x 20	185	165
0488	17 x 22	200	240
0490	19 x 22	200	240
0492	20 x 22	200	240
0494	19 x 24	220	300
0496	21 x 23	220	300
0498	22 x 24	220	300
0500	22 x 27	240	390
0502	23 x 26	240	390
0504	24 x 27	240	390
0506	25 x 28	260	485
0508	24 x 30	260	485
0510	27 x 30	260	485
0512	27 x 32	285	650
0514	30 x 32	285	650
0516	30 x 36	310	850
0518	32 x 36	310	850
0520	36 x 41	340	1150
0522	41 x 46	375	1500
0524	46 x 50	415	1900
0526	50 x 55	455	2500
0528	50 x 60	505	3200
0530	55 x 60	505	3200
0532	65 x 70	555	4600

American Inch (")			
Number	s1 x s2 inch	l inch	Wt. lbs.
W-697	1/4 x 5/16	5 1/4	0.16
W-698	3/8 x 7/16	5 1/4	0.16
W-699	7/16 x 1/2	5 1/4	0.14
W-700	1/2 x 5/8	6	0.32
W-702	1/2 x 11/16	6	0.32
W-704	9/16 x 5/8	6	0.34
W-706	9/16 x 3/4	6 3/4	0.58
W-710	5/8 x 3/4	6 3/4	0.54
W-712	11/16 x 25/32	6 3/4	0.54
W-718	11/16 x 7/8	6 3/4	0.52
W-720	3/4 x 13/16	9 1/4	0.84
W-722	3/4 x 7/8	9 1/4	0.84
W-724	25/32 x 7/8	9 1/4	0.86
W-732	7/8 x 15/16	9 1/4	1.08
W-736	7/8 x 1	9 1/4	1.08
W-738	7/8 x 1 1/16	10 3/4	1.36
W-740	15/16 x 1 1/16	10 3/4	1.34
W-741	1 x 1 1/8	10 3/4	1.34
W-748	1 1/16 x 1 1/4	13 3/8	2.64
W-750	1 1/8 x 1 5/16	13 3/8	2.64
W-754	1 1/8 x 1 1/2	15 1/4	3.74
W-756	1 1/4 x 1 7/16	15 1/4	3.76
W-760	1 1/4 x 1 5/8	15 1/4	3.94
W-764	1 7/16 x 1 5/8	16 3/4	4.26
W-772	1 5/8 x 1 13/16	18 3/4	8.56
W-778	1 13/16 x 2	18 3/4	8.34

**AMPCO RECOMMENDS
REGULAR ASSESSMENTS OF
WORK PLACE HAZARDS**

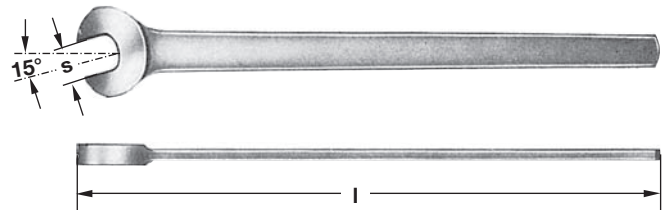

Wrench, Open End, Long Handle 15° off-set
Clé à fourche à manche long
Llave de Boca de Mango Largo

Millimeter (mm)			
Number	s mm	l mm	Wt. g
2500	22	320	450
2502	23	320	450
2504	24	348	600
2506	25	348	600
2508	26	380	850
2510	27	380	850
2512	28	416	1050
2514	29	416	1050
2516	30	416	1050
2518	32	453	1350
2520	33	453	1350
2522	34	453	1350
2524	35	497	1700
2526	36	497	1700
2528	37	497	1700
2530	38	497	1700
2532	41	546	2350
2534	42	546	2350
2536	46	600	2800
2538	47	600	2800
2540	50	662	4000
2542	52	662	4000
2544	54	662	4000
2546	55	730	5300
2548	56	730	5300
2550	58	805	6850
2552	60	805	6850



DANGER SIGN - Ask about our free DANGER SIGN for your facility to remind your employees of the specific hazards in a particular area.
(Offer good while supplies last.)

American Inch (")			
Number	s inch	l inch	Wt. lbs.
2650	13/16	12 1/2	0.99
2652	7/8	12 1/2	0.99
2654	15/16	13 3/4	1.32
2656	31/32	13 3/4	1.32
2658	1	15	1.87
2660	1 1/16	15	1.87
2662	1 1/8	16 1/4	2.32
2664	1 3/16	16 1/4	2.32
2666	1 1/4	16 1/4	2.32
2668	1 5/16	16 1/4	2.32
2670	1 3/8	19 1/2	3.75
2672	1 7/16	19 1/2	3.75
2674	1 1/2	19 1/2	3.75
2676	1 9/16	21 1/2	5.18
2678	1 5/8	21 1/2	5.18
2680	1 11/16	23 1/2	6.17
2682	1 3/4	23 1/2	6.17
2684	1 13/16	23 1/2	6.17
2686	1 7/8	26	8.82
2688	2	26	8.82
2690	2 1/16	26	8.82
2692	2 1/8	28 3/4	11.69
2694	2 3/16	28 3/4	11.69
2696	2 1/4	31 3/4	15.10
2698	2 5/16	31 3/4	15.10
2700	2 3/8	31 3/4	15.10

Millimeter (mm)			
Number	s mm	l mm	Wt. g
2814	29	416	1050
2816	30	416	1050
2818	32	453	1350
2820	33	453	1350
2822	34	453	1350
2824	35	497	1700
2826	36	497	1700
2828	37	497	1700
2830	38	497	1700
2832	41	546	2350
2834	42	546	2350
2836	46	600	2800
2838	47	600	2800
2840	50	662	4000
2842	52	662	4000
2844	54	662	4000
2846	55	730	5300
2848	56	730	5300
2850	58	805	6850
2852	60	805	6850

American Inch (")			
Number	s inch	l inch	Wt. lbs.
2950	13/16	12 1/2	0.99
2952	7/8	12 1/2	0.99
2954	15/16	13 3/4	1.32
2956	31/32	13 3/4	1.32
2958	1	15	1.87
2960	1 1/16	15	1.87
2962	1 1/8	16 1/4	2.32
2964	1 3/16	16 1/4	2.32
2966	1 1/4	16 1/4	2.32
2968	1 5/16	16 1/4	2.32
2970	1 3/8	19 1/2	3.75
2972	1 7/16	19 1/2	3.75
2974	1 1/2	19 1/2	3.75
2976	1 9/16	21 1/2	5.18
2978	1 5/8	21 1/2	5.18
2980	1 11/16	23 1/2	6.17
2982	1 3/4	23 1/2	6.17
2984	1 13/16	23 1/2	6.17
2986	1 7/8	26	8.82
2988	2	26	8.82
2990	2 1/16	26	8.82
2992	2 1/8	28 3/4	11.69
2994	2 3/16	28 3/4	11.69
2996	2 1/4	31 1/2	15.10
2998	2 5/16	31 1/2	15.10
3000	2 3/8	31 1/2	15.100

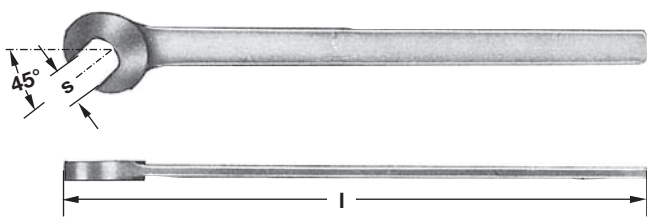

Wrench, Open End, Long Handle 45° off-set
Clé à fourche à manche long
Llave de Boca de Mango Largo

Millimeter (mm)			
Number	s mm	l mm	Wt. g
2800	22	320	450
2802	23	320	450
2804	24	348	600
2806	25	348	600
2808	26	380	850
2810	27	380	850
2812	28	416	1050

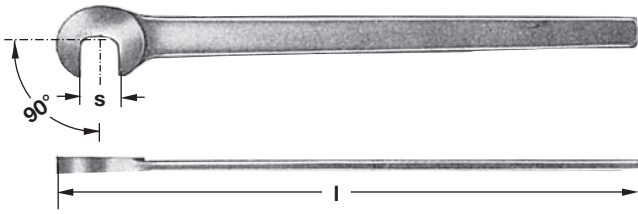

Wrench, Open End, Long Handle 90° off-set
Clé à fourche à manche long
Llave de Boca de Mango Largo

Millimeter (mm)			
Number	s mm	l mm	⚖ g
3100	22	320	450
3102	23	320	450
3104	24	348	600
3106	25	348	600
3108	26	380	850
3110	27	380	850
3112	28	416	1050
3114	29	416	1050
3116	30	416	1050
3118	32	453	1350
3120	33	453	1350
3122	34	453	1350
3124	35	497	1700
3126	36	497	1700
3128	37	497	1700
3130	38	497	1700
3132	41	546	2350
3134	42	546	2350
3136	46	600	2800
3138	47	600	2800
3140	50	662	4000
3142	52	662	4000
3144	54	662	4000
3146	55	730	5300
3148	56	730	5300
3150	58	805	6850
3152	60	805	6850

American Inch (")			
Number	s inch	l inch	Wt. lbs.
3250	13/16	12 1/2	0.99
3252	7/8	12 1/2	0.99
3254	15/16	13 3/4	1.32
3256	31/32	13 3/4	1.32
3258	1	15	1.87
3260	1 1/16	15	1.87
3262	1 1/8	16 1/4	2.32
3264	1 3/16	16 1/4	2.32
3266	1 1/4	16 1/4	2.32

Number	s inch	l inch	Wt. lbs.
3268	1 5/16	16 1/4	2.32
3270	1 3/8	19 1/2	3.75
3272	1 7/16	19 1/2	3.75
3274	1 1/2	19 1/2	3.75
3276	1 9/16	21 1/2	5.18
3278	1 5/8	21 1/2	5.18
3280	1 11/16	23 1/2	6.17
3282	1 3/4	23 1/2	6.17
3284	1 13/16	23 1/2	6.17
3286	1 7/8	26	8.82
3288	2	26	8.82
3290	2 1/16	26	8.82
3292	2 1/8	28 3/4	11.69
3294	2 3/16	28 3/4	11.69
3296	2 1/4	31 3/4	15.10
3298	2 5/16	31 3/4	15.10
3300	2 3/8	31 3/4	15.10

- **A Tool for Every Purpose and a Kit for Any Job!**
- **Un Outil pour Chaque Usage et un Jeu D'outils pour Quel Tâche**
- **¡Una Herramienta para Cada Propósito y un Juego de Herramientas para Cualquier Trabajo!**

AMPCO CUSTOM KITS

- **MIX & MATCH... there is no CATCH!**
- **CRÉZ UN ASSORTIMENT... il n'y a pas de PIÈGE!**
- **¡COMBÍNELAS,.... y no hay PROBLEMA!**

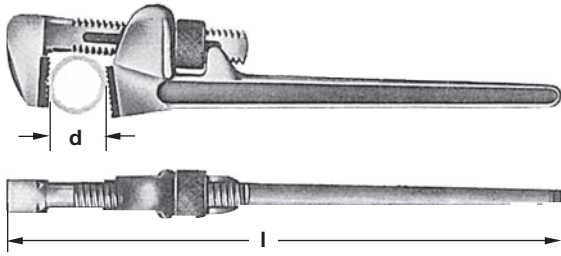

Wrench, Pipe, Aluminum
Clé serre-tube, aluminium forgé
Llave para Tubos

Number	d max mm	l mm	△ g	d max inch	l inch	Wt. lbs.
W-211AL	25	255	680	1	10	1.50
W-212AL	38	355	1020	1½	14	2.25
W-213AL	50	460	1435	2	18	3.16
W-214AL	65	610	2600	2½	24	5.75
W-215AL	90	915	4535	3½	36	10.00
W-216AL	130	1219	8170	5	48	18.00

Replacement parts available upon request
 Pièces de rechange disponibles sur demande
 Reemplazo de repuestos

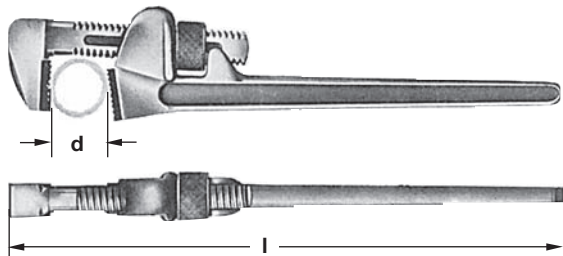

Wrench, Pipe, Bronze
Clé serre-tube
Llave para Tubos

Number	d max mm	l mm	△ g	d max inch	l inch	Wt. lbs.
W-210	19	205	600	¾	8	1.32
W-211	25	255	990	1	10	2.10
W-212	38	355	1600	1½	14	3.24
W-213	50	460	2200	2	18	4.72
W-214	65	610	4050	2½	24	8.72
W-215	90	915	7350	3½	36	16.18
W-216	130	1219	13800	5	48	30.38

Replacement parts available upon request
 Pièces de rechange disponibles sur demande
 Reemplazo de repuestos



Wrench, Socket, 6-Point (DIN 3112)
Clé à douille, 6 pans
Llave para Cubos, 6-Puntos

Millimeter (mm)				
Number	s mm	d2 mm	l mm	△ g
5500	8	6,7	190	110
5502	9	6,7	200	135
5504	10	6,7	215	160
5506	11	8,4	230	210
5508	12	8,4	250	260
5510	13	10	265	350
5512	14	10	265	350
5514	15	10	280	400
5516	16	10	280	400
5518	17	11,6	300	450
5520	18	11,6	300	450
5522	19	11,6	325	650
5524	20	11,6	325	650
5526	21	11,6	350	830
5528	22	11,6	350	830
5530	23	13,2	380	1140
5532	24	13,2	380	1140
5534	25	13,2	415	1450
5536	26	13,2	415	1450
5538	27	13,2	415	1450
5540	28	16,4	450	1800
5542	29	16,4	450	1800
5544	30	16,4	450	1800
5546	32	16,4	485	2450
5548	33	16,4	485	2450
5550	34	16,4	485	2450
5552	35	18	530	3300
5554	36	18	530	3300
5556	37	18	530	3300
5558	38	18	530	3300
5560	41	21,6	580	4000
5562	42	21,6	580	4000
5564	46	21,6	635	4800
5566	47	21,6	635	4800
5568	50	26,6	320	4900
5570	52	26,6	320	4900
5572	54	26,6	340	6500
5574	55	26,6	340	6500
5576	56	26,6	340	6500
5578	58	26,6	360	8300
5580	60	26,6	360	8300

Number	s mm	d2 mm	l mm	ΔΔ g
5582	63	26,6	360	8300
5584	65	33	380	10500
5586	67	33	380	10500
5588	70	33	380	10500
5590	71	33	380	10500
5592	75	33	400	14300
5594	77	33	400	14300
5596	80	33	400	14300
5598	82	33	400	14300
5600	85	40	425	19200
5602	88	40	425	19200
5604	90	40	425	19200
5606	94	40	455	26000
5608	95	40	455	26000
5610	100	40	455	26000

American Inch (")

Number	s inch	d2 inch	l inch	Wt. lbs.
5700	5/16	17/64	7 1/2	0.24
5702	11/32	17/64	7 3/4	0.30
5704	3/8	17/64	8 1/2	0.35
5706	13/32	21/64	9	0.46
5708	7/16	21/64	9 3/4	0.57
5710	1/2	25/64	10 1/2	0.77
5712	9/16	25/64	10 1/2	0.77
5714	19/32	25/64	11	0.88
5716	5/8	25/64	11	0.88
5718	11/16	29/64	11 3/4	0.98
5720	3/4	29/64	12 3/4	1.43
5722	25/32	29/64	12 3/4	1.43
5724	13/16	29/64	13 3/4	1.83
5726	7/8	29/64	13 3/4	1.83
5728	15/16	33/64	15	2.51
5730	31/32	33/64	16 1/4	3.20
5732	1	33/64	16 1/4	3.20
5734	1 1/16	33/64	16 1/4	3.20
5736	1 1/8	41/64	17 3/4	3.97
5738	1 3/16	41/64	17 3/4	3.97
5740	1 1/4	41/64	19	5.40
5742	1 5/16	41/64	19	5.40
5744	1 3/8	45/64	20 3/4	7.28
5746	1 7/16	45/64	20 3/4	7.28
5748	1 1/2	45/64	20 3/4	7.28
5750	1 9/16	55/64	20 3/4	8.82
5752	1 5/8	55/64	22 3/4	8.82
5754	1 11/16	55/64	22 3/4	8.82
5756	1 3/4	55/64	25	10.58
5758	1 13/16	55/64	25	10.58
5760	1 7/8	55/64	25	10.58
5762	2	1 3/64	12 1/2	10.80
5764	2 1/16	1 3/64	12 1/2	10.80
5766	2 1/8	1 3/64	13 1/4	14.33
5768	2 3/16	1 3/64	13 1/4	14.33

Number	s inch	d2 inch	l inch	Wt. lbs.
5770	2 1/4	1 3/64	14 1/4	18.30
5772	2 5/16	1 3/64	14 1/4	18.30
5774	2 3/8	1 3/64	14 1/4	18.30
5776	2 7/16	1 19/64	14 1/4	18.30
5778	2 1/2	1 19/64	15	23.15
5780	2 9/16	1 19/64	15	23.15
5782	2 5/8	1 19/64	15	23.15
5784	2 3/4	1 19/64	15	23.15
5786	2 13/16	1 19/64	15 3/4	31.53
5788	2 15/16	1 19/64	15 3/4	31.53
5790	3	1 19/64	15 3/4	31.53
5792	3 1/8	1 19/64	15 3/4	31.53
5794	3 1/4	1 19/64	15 3/4	31.53
5796	3 3/8	1 37/64	16 3/4	42.34
5798	3 1/2	1 37/64	16 3/4	42.34
5800	3 5/8	1 37/64	18	57.33
5802	3 3/4	1 37/64	18	57.33
5804	3 7/8	1 37/64	18	57.33

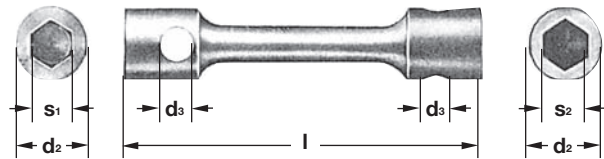

Wrench, Socket, 6 Point, Double End (DIN 896)
Clé à double douille, 6 pans
Llave para Cubos, 6-Puntos, Double Cabeza

Number	s1 x s2 mm	d1 mm	d2 mm	d3 mm	l mm	ΔΔ g
6300	7 x 8	11	12	5,2	95	50
6302	9 x 10	14	15	6,7	105	70
6304	10 x 11	15	16	6,7	120	85
6306	12 x 14	18	22	10	135	160
6308	14 x 17	22	25	10	150	205
6310	17 x 19	25	28	13,3	160	280
6312	19 x 22	28	32	13,3	170	335
6314	20 x 22	29	32	13,3	170	335
6316	24 x 26	34	37	15	180	480
6318	24 x 27	34	38	15	190	530
6320	27x 32	40	45	16,5	200	870
6322	30 x 32	42	45	16,5	210	890
6324	30 x 36	42	51	16,5	220	1080
6326	36 x 41	51	57	16,5	230	1700

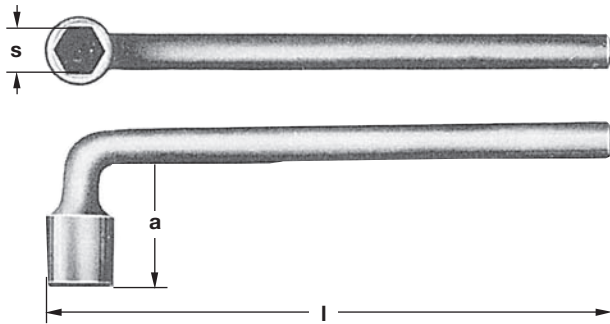

Wrench, Socket, L-type, 6-Point

Clé à pipe, 6 Pans

Llave para Cubos, Tipo-L, 6-Puntos

Millimeter (mm)				
Number	s mm	a mm	l mm	Wt. g
5900	8	33	175	100
5902	9	35	185	120
5904	10	37	195	140
5906	11	39	205	180
5908	12	42	220	220
5910	13	45	240	280
5912	14	45	240	280
5914	15	48	250	300
5916	16	48	250	300
5918	17	51	270	320
5920	18	51	270	320
5922	19	55	290	530
5924	20	55	290	530
5926	21	59	310	680
5928	22	59	310	680
5930	23	63	335	830
5932	24	63	335	830
5934	25	69	365	1000
5936	26	69	365	1000
5938	27	96	365	1000
5940	28	75	395	1300
5942	29	75	395	1300
5944	30	75	395	1300
5946	32	81	425	1700
5948	33	81	425	1700
5950	34	81	425	1700
5952	35	89	465	2800
5954	36	89	465	2800
5956	37	89	465	2800
5958	38	89	465	2800
5960	41	96	510	3600
5962	42	96	510	3600
5964	46	105	555	4000
5966	47	105	555	4000
5968	50	114	605	4800
5970	52	114	605	4800
5972	54	120	660	6400
5974	55	120	660	6400
5976	56	120	660	6400
5978	58	138	730	8200
5980	60	138	730	8200
5982	63	138	730	8200
5984	65	150	800	10400

Millimeter (mm)				
Number	s mm	a mm	l mm	Wt. g
5986	67	150	800	10400
5988	70	150	800	10400
5990	71	150	800	10400
5992	75	166	880	14100
5994	77	166	880	14100
5996	80	166	880	14100
5998	82	166	880	14100
American Inch (")				
Number	s inch	a inch	l inch	Wt. lbs.
6100	⁵ / ₁₆	1 ¹ / ₅	8 ³ / ₄	.22
6102	¹¹ / ₃₂	1 ¹ / ₄	7 ¹ / ₄	.26
6104	³ / ₈	1 ¹ / ₂	7 ¹ / ₂	.31
6106	¹³ / ₃₂	1 ¹ / ₂	8	.40
6108	⁷ / ₁₆	1 ⁵ / ₈	8 ¹ / ₂	.49
6110	¹ / ₂	1 ³ / ₄	9 ¹ / ₂	.62
6112	⁹ / ₁₆	1 ³ / ₄	9 ¹ / ₂	.62
6114	¹⁹ / ₃₂	1 ⁷ / ₈	9 ³ / ₄	.66
6116	⁵ / ₈	1 ⁷ / ₈	9 ³ / ₄	.66
6118	¹¹ / ₁₆	2	10 ¹ / ₂	.71
6120	³ / ₄	2 ¹¹ / ₆₄	11 ¹ / ₂	1.17
6122	²⁵ / ₃₂	2 ¹¹ / ₆₄	11 ¹ / ₂	1.17
6124	¹³ / ₁₆	2 ⁵ / ₁₆	12 ¹ / ₄	1.50
6126	⁷ / ₈	2 ⁵ / ₁₆	12 ¹ / ₄	1.50
6128	¹⁵ / ₁₆	2 ¹⁵ / ₃₂	13 ¹ / ₄	1.83
6130	³¹ / ₃₂	2 ²³ / ₃₂	14 ¹ / ₄	2.21
6132	1	2 ²³ / ₃₂	14 ¹ / ₄	2.21
6134	1 ¹ / ₁₆	2 ²³ / ₃₂	14 ¹ / ₄	2.21
6136	1 ¹ / ₈	2 ⁶¹ / ₆₄	15 ¹ / ₂	2.87
6138	1 ³ / ₁₆	2 ⁶¹ / ₆₄	15 ¹ / ₂	2.87
6140	1 ¹ / ₄	3 ³ / ₁₆	16 ³ / ₄	3.75
6142	1 ⁵ / ₁₆	3 ³ / ₁₆	16 ³ / ₄	3.75
6144	1 ³ / ₈	3 ¹ / ₂	18 ¹ / ₄	6.17
6146	1 ⁷ / ₁₆	3 ¹ / ₂	18 ¹ / ₄	6.17
6148	1 ¹ / ₂	3 ¹ / ₂	18 ¹ / ₄	6.17
6150	1 ⁹ / ₁₆	3 ²⁵ / ₃₂	20	7.94
6152	1 ⁵ / ₈	3 ²⁵ / ₃₂	20	7.94
6154	1 ¹¹ / ₁₆	3 ²⁵ / ₃₂	20	7.94
6156	1 ³ / ₄	4 ¹ / ₈	21 ³ / ₄	8.82
6158	1 ¹³ / ₁₆	4 ¹ / ₈	21 ³ / ₄	8.82
6160	1 ⁷ / ₈	4 ¹ / ₈	21 ³ / ₄	8.82
6162	2	4 ¹ / ₂	23 ³ / ₄	10.58
6164	2 ¹ / ₁₆	4 ¹ / ₂	23 ³ / ₄	10.58
6166	2 ¹ / ₂	4 ²³ / ₃₂	26	14.11
6168	2 ³ / ₁₆	4 ²³ / ₃₂	26	14.11
6170	2 ¹ / ₄	4 ⁷ / ₁₆	28 ³ / ₄	18.08
6172	2 ⁵ / ₁₆	4 ⁷ / ₁₆	28 ³ / ₄	18.08
6174	2 ⁹ / ₁₆	4 ⁷ / ₁₆	28 ³ / ₄	18.08
6176	2 ⁷ / ₁₆	4 ⁷ / ₁₆	28 ³ / ₄	18.08
6178	2 ¹ / ₂	5 ²⁹ / ₃₂	31 ¹ / ₂	22.93
6180	2 ⁹ / ₁₆	5 ²⁹ / ₃₂	31 ¹ / ₂	22.93
6182	2 ⁵ / ₈	5 ²⁹ / ₃₂	31 ¹ / ₂	22.93
6184	2 ³ / ₄	5 ²⁹ / ₃₂	31 ¹ / ₂	22.93
6186	2 ¹³ / ₁₆	6 ¹⁷ / ₃₂	34 ¹ / ₂	31.09
6188	2 ¹⁵ / ₁₆	6 ¹⁷ / ₃₂	34 ¹ / ₂	31.09
6190	3	6 ¹⁷ / ₃₂	34 ¹ / ₂	31.09
6192	3 ¹ / ₈	6 ¹⁷ / ₃₂	34 ¹ / ₂	31.09
6194	3 ¹ / ₄	6 ¹⁷ / ₃₂	34 ¹ / ₂	31.09

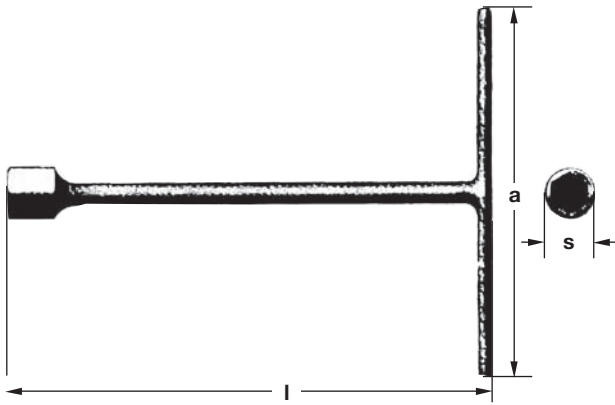

Wrench, Socket, T-type, 6-Point
Clé à douille, en "T", 6 pans
Llave para Cubos, Tipo-T, 6-Puntos

Millimeter (mm)				
Number	s mm	a mm	l mm	Wt. g
5100	8	150	196	140
5102	9	165	209	165
5104	10	180	223	190
5106	11	195	240	260
5108	12	215	256	310
5110	13	235	275	410
5112	14	235	275	410
5114	15	260	292	455
5116	16	260	292	455
5118	17	290	314	555
5120	18	290	314	555
5122	19	315	339	785
5124	20	315	339	785
5126	21	355	376	1050
5128	22	355	376	1050
5130	23	390	393	1240
5132	24	390	393	1240
5134	25	435	431	1700
5136	26	435	431	1700
5138	27	435	431	1700
5140	28	480	464	2100
5142	29	480	464	2100
5144	30	480	464	2100
5146	32	530	506	2750
5148	33	530	506	2750
5150	34	530	506	2750
5152	35	585	550	4000
5154	36	585	550	4000
5156	37	585	550	4000
5158	38	585	550	4000
5160	41	650	600	5400
5162	42	650	600	5400
5164	46	720	655	6000
5166	47	720	655	6000
5168	50	800	345	6300
5170	52	800	345	6300
5172	54	900	365	8000
5174	55	900	365	8000
5176	56	900	365	8000
5178	58	1000	390	10500
5180	60	1000	390	10500
5182	63	1000	390	10500

Millimeter (mm)				
Number	s mm	a mm	l mm	Wt. g
5184	65	1130	410	14000
5186	67	1130	410	14000
5188	70	1130	410	14000
5190	71	1130	410	14000
5192	75	1270	430	19000
5194	77	1270	430	19000
5196	80	1270	430	19000
5198	82	1270	430	19000

American Inch (")				
Number	s inch	a inch	l inch	Wt. lbs.
5300	⁵ / ₁₆	6	7 ¹ / ₂	.31
5302	¹¹ / ₃₂	6 ¹ / ₂	8 ³ / ₄	.36
5304	³ / ₈	7	8 ³ / ₄	.42
5306	¹³ / ₃₂	7 ¹ / ₂	9 ¹ / ₂	.57
5308	⁷ / ₁₆	8 ¹ / ₂	10	.68
5310	¹ / ₂	9 ¹ / ₄	10 ³ / ₄	.90
5312	⁹ / ₁₆	9 ¹ / ₄	10 ³ / ₄	.90
5314	¹⁹ / ₃₂	10 ¹ / ₄	11 ¹ / ₂	1.00
5316	⁵ / ₈	10 ¹ / ₄	11 ¹ / ₂	1.00
5318	¹¹ / ₁₆	11 ¹ / ₂	12 ¹ / ₂	1.22
5320	³ / ₄	12 ¹ / ₂	13 ¹ / ₂	1.73
5322	²⁵ / ₃₂	12 ¹ / ₂	13 ¹ / ₂	1.73
5324	¹³ / ₁₆	14	14 ³ / ₄	2.32
5326	⁷ / ₈	14	14 ³ / ₄	2.32
5328	¹⁵ / ₁₆	15 ¹ / ₄	15 ¹ / ₂	2.73
5330	³¹ / ₃₂	17	17	3.75
5332	1	17	17	3.75
5334	¹ / ₁₆	17	17	3.75
5336	¹ / ₈	19	18 ¹ / ₄	4.63
5338	¹³ / ₁₆	19	18 ¹ / ₄	4.63
5340	¹ / ₄	20 ³ / ₄	20	6.06
5342	¹⁵ / ₁₆	20 ³ / ₄	20	6.06
5344	¹³ / ₈	23	21 ¹ / ₂	8.82
5346	¹⁷ / ₁₆	23	21 ¹ / ₂	8.82
5348	¹ / ₂	23	21 ¹ / ₂	8.82
5350	¹⁹ / ₁₆	25 ¹ / ₂	23 ¹ / ₂	11.91
5352	¹⁵ / ₈	25 ¹ / ₂	23 ¹ / ₂	11.91
5354	¹¹ / ₁₆	25 ¹ / ₂	23 ¹ / ₂	11.91
5356	¹³ / ₄	28 ¹ / ₄	25 ³ / ₄	13.23
5358	¹¹³ / ₁₆	28 ¹ / ₄	25 ³ / ₄	13.23
5360	¹⁷ / ₈	28 ¹ / ₄	25 ³ / ₄	13.23
5362	2	31 ¹ / ₂	13 ¹ / ₂	13.89
5364	²¹ / ₁₆	31 ¹ / ₂	13 ¹ / ₂	13.89
5366	²¹ / ₈	35 ¹ / ₂	14 ¹ / ₄	17.64
5368	²³ / ₁₆	35 ¹ / ₂	14 ¹ / ₄	17.64
5370	²¹ / ₄	39 ³ / ₄	15 ¹ / ₄	23.15
5372	²⁵ / ₁₆	39 ³ / ₄	15 ¹ / ₄	23.15
5374	²³ / ₈	39 ³ / ₄	15 ¹ / ₄	23.15
5376	²⁷ / ₁₆	39 ³ / ₄	15 ¹ / ₄	23.15
5378	²¹ / ₂	44 ¹ / ₂	16	30.87
5380	²⁹ / ₁₆	44 ¹ / ₂	16	30.87
5382	²⁵ / ₈	44 ¹ / ₂	16	30.87
5384	²³ / ₄	44 ¹ / ₂	16	30.87
5386	²¹³ / ₁₆	50	17	41.90
5388	²¹⁵ / ₁₆	50	17	41.90
5390	3	50	17	41.90
5392	³¹ / ₈	50	17	41.90
5394	³¹ / ₄	50	17	41.90

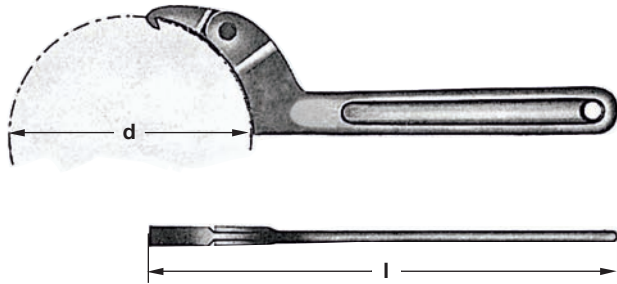

Wrench, Spanner, Adjustable
Clé à ergot articulée
Llave de Gancho Ajustable

Number	d mm	l mm	⚖ g	d inch	l inch	Wt. lbs.
WP-5-ST	32-75	205	230	1 ¹ / ₄ - 3	8	.48
WP-6-ST	50-120	285	450	2 - 4 ³ / ₄	11	.98
WP-7-ST	115-170	310	500	4 ¹ / ₂ - 6 ³ / ₈	12	1.12

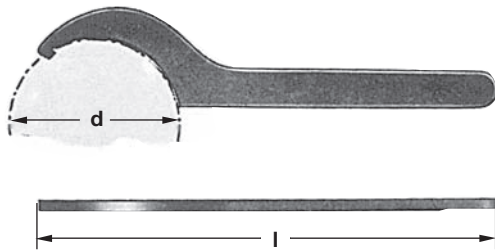

Wrench, Spanner, Fixed (DIN 1810)
Clé à ergot
Llave de Gancho

Number	d mm	l mm	q g	d inch	l inch	Wt. lbs.
7400	12-14	110	30	15/32 - 9/16	4 ¹ / ₄	.07
7402	16-20	110	30	5/8 - 13/16	4 ¹ / ₄	.07
7404	25-28	136	50	31/32 - 11/8	5 ¹ / ₄	1.97
7406	30-32	136	50	13/16 - 11/4	5 ¹ / ₄	1.97
7408	34-36	170	100	15/16 - 17/16	6 ³ / ₄	3.94
7410	40-42	170	100	19/16 - 111/16	6 ³ / ₄	3.94
7412	45-50	205	190	1 ³ / ₄ - 2	8	7.48
7414	52-55	205	190	2 ¹ / ₁₆ - 2 ³ / ₁₆	8	7.48
7416	58-62	245	265	2 ¹ / ₄ - 2 ⁷ / ₁₆	9 ³ / ₄	10.43
7418	68-75	245	265	2 ¹¹ / ₁₆ - 3	9 ³ / ₄	10.43
7420	80-90	285	410	3 ¹ / ₈ - 3 ¹ / ₂	11 ¹ / ₄	16.14
7422	95-100	285	410	3 ³ / ₄ - 4	11 ¹ / ₄	16.14
7424	110-115	335	730	4 ⁵ / ₁₆ - 4 ⁹ / ₁₆	13 ¹ / ₄	28.74
7426	120-130	335	730	4 ¹¹ / ₁₆ - 5 ¹ / ₈	13 ¹ / ₄	28.74
7428	135-145	385	1150	5 ⁵ / ₁₆ - 5 ³ / ₄	15 ¹ / ₄	45.28
7430	155-165	385	1150	6 ¹ / ₈ - 6 ¹ / ₂	15 ¹ / ₄	45.28

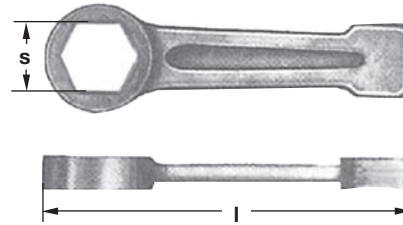

Wrench, Striking Box, 6-Point
Clé à frapper polygonale, 6 pans
Llave de Cajón de Golpe, 6-Puntos

American Inch (")			
Number	s inch	l inch	Wt. lbs.
WS-1808	1 ¹ / ₄	6 ¹ / ₂	1.20
WS-1808A	1 ⁵ / ₁₆	7 ¹ / ₂	1.52
WS-1809	1 ⁷ / ₁₆	7 ¹ / ₂	1.44
WS-1809A	1 ¹ / ₂	8 ³ / ₄	2.54
WS-1810	1 ⁵ / ₈	8 ³ / ₄	2.38
WS-1810A	1 ¹¹ / ₁₆	9 ⁷ / ₈	3.22
WS-1811	1 ¹³ / ₁₆	9 ⁷ / ₈	3.04
WS-1811A	1 ⁷ / ₈	10 ⁵ / ₈	3.42
WS-1812	2	10 ⁵ / ₈	3.32
WS-1813	2 ³ / ₁₆	11 ¹ / ₂	4.32
WS-1814	2 ³ / ₈	12 ¹ / ₄	4.06
WS-1815	2 ⁹ / ₁₆	13 ¹ / ₂	5.32
WS-1815A	2 ⁵ / ₈	13 ¹ / ₂	5.30
WS-1816	2 ³ / ₄	17	7.60

More sizes available upon request.

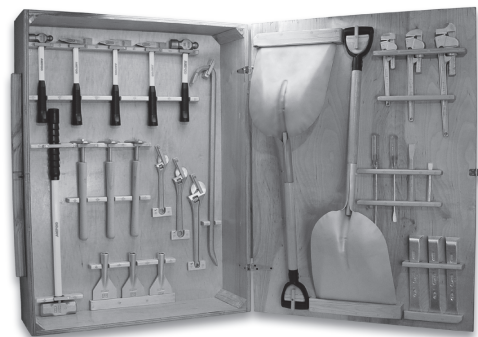

AMPCO's CUSTOM CABINETS

Create your own Cabinet
 to meet your tool needs!

See page 67

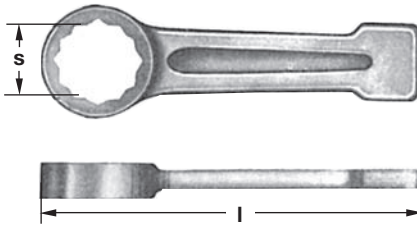

Wrench, Striking Box ,12-Point (DIN 7444)
Clé à frapper polygonale, 12 pans
Llave de Cajón de Golpe, 12-Puntos

Millimeter (mm)			
Number	s mm	l mm	Δ g
WS-17	17	160	272
WS-19	19	160	272
WS-22	22	160	272
WS-24	24	160	272
WS-27	27	180	363
WS-28	28	180	308
WS-29	29	180	308
WS-30	30	200	590
WS-32	32	200	590
WS-33	33	200	590
WS-34	34	200	590
WS-35	35	200	544
WS-36	36	200	544
WS-37	37	200	522
WS-38	38	200	522
WS-41	41	230	862
WS-42	42	230	862
WS-46	46	230	862
WS-47	47	230	816
WS-50	50	255	1361
WS-52	52	255	1270
WS-54	54	255	1270
WS-55	55	255	1225
WS-56	56	255	1216
WS-58	58	285	2041
WS-60	60	285	1996
WS-63	63	285	1905
WS-65	65	285	1860
WS-67	67	330	3221
WS-70	70	330	2948
WS-71	71	330	2948
WS-75	75	330	2858
WS-77	77	360	4128
WS-80	80	360	4128
WS-82	82	360	3901
WS-85	85	360	3810
WS-88	88	395	6441
WS-90	90	395	6350
WS-94	94	395	6078
WS-95	95	395	5987
WS-100	100	395	5670
WS-105	105	435	10000
WS-110	110	435	10000
WS-115	115	435	10000
WS-120	120	510	23000
WS-125	125	510	23000

Millimeter (mm)			
Number	s mm	l mm	Δ g
WS-130	130	510	23000
WS-135	135	510	23000
WS-145	145	565	30000
WS-150	150	565	30000
WS-155	155	565	30000
American Inch (")			
Number	s inch	l inch	Wt. lbs.
WS-11/16	1 ¹ / ₁₆	6 ⁵ / ₁₆	.6
WS-3/4	3/4	6 ⁵ / ₁₆	.6
WS-7/8	7/8	6 ⁵ / ₁₆	.6
WS-1	1	6 ⁵ / ₁₆	.6
WS-1-1/16	1 ¹ / ₁₆	7	.78
WS-1-1/8	1 ¹ / ₈	7	.7
WS-1-3/16	1 ³ / ₁₆	7 ⁷ / ₈	1.3
WS-1-1/4	1 ¹ / ₄	7 ⁷ / ₈	1.3
WS-1-5/16	1 ⁵ / ₁₆	7 ⁷ / ₈	1.3
WS-1-3/8	1 ³ / ₈	7 ⁷ / ₈	1.2
WS-1-7/16	1 ⁷ / ₁₆	7 ⁷ / ₈	1.14
WS-1-1/2	1 ¹ / ₂	9	1.96
WS-1-9/16	1 ⁹ / ₁₆	9	1.88
WS-1-5/8	1 ⁵ / ₈	9	1.88
WS-1-11/16	1 ¹¹ / ₁₆	9	1.8
WS-1-3/4	1 ³ / ₄	9	1.8
WS-1-13/16	1 ¹³ / ₁₆	9	1.75
WS-1-7/8	1 ⁷ / ₈	10	3.1
WS-2	2	10	2.92
WS-2-1/16	2 ¹ / ₁₆	10	2.84
WS-2-1/8	2 ¹ / ₈	10	2.82
WS-2-3/16	2 ³ / ₁₆	10	2.68
WS-2-1/4	2 ¹ / ₄	11 ¹ / ₄	4.6
WS-2-5/16	2 ⁵ / ₁₆	11 ¹ / ₄	4.4
WS-2-3/8	2 ³ / ₈	11 ¹ / ₄	4.4
WS-2-7/16	2 ⁷ / ₁₆	11 ¹ / ₄	4.3
WS-2-1/2	2 ¹ / ₂	11 ¹ / ₄	4.2
WS-2-9/16	2 ⁹ / ₁₆	11 ¹ / ₄	4.2
WS-2-5/8	2 ⁵ / ₈	13	6.84
WS-2-3/4	2 ³ / ₄	13	6.8
WS-2-13/16	2 ¹³ / ₁₆	13	6.78
WS-2-15/16	2 ¹⁵ / ₁₆	13	6.32
WS-3	3	14 ³ / ₁₆	9.21
WS-3-1/8	3 ¹ / ₈	14 ³ / ₁₆	9.06
WS-3-1/4	3 ¹ / ₄	14 ³ / ₁₆	8.64
WS-3-3/8	3 ³ / ₈	15 ¹ / ₂	14.6
WS-3-1/2	3 ¹ / ₂	15 ¹ / ₂	14.08
WS-3-5/8	3 ⁵ / ₈	15 ¹ / ₂	13.7
WS-3-3/4	3 ³ / ₄	15 ¹ / ₂	13.1
WS-3-7/8	3 ⁷ / ₈	15 ¹ / ₂	12.6
WS-4	4	17 ⁷ / ₈	22
WS-4-1/8	4 ¹ / ₈	17 ⁷ / ₈	22
WS-4-5/16	4 ⁵ / ₁₆	17 ⁷ / ₈	22
WS-4-9/16	4 ⁹ / ₁₆	20	51
WS-4-11/16	4 ¹¹ / ₁₆	20	51
WS-4-15/16	4 ¹⁵ / ₁₆	20	51
WS-5-1/8	5 ¹ / ₈	20	51
WS-5-3/8	5 ³ / ₈	22 ¹ / ₄	66
WS-5-11/16	5 ¹¹ / ₁₆	22 ¹ / ₄	66
WS-6	6	22 ¹ / ₄	66

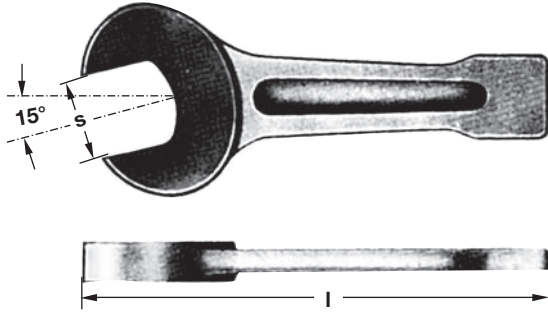

Wrench, Striking Open End (DIN 133)

Clé à frapper à fourche

Llave de Boca de Golpe

Millimeter (mm)			
Number	s mm	l mm	Δ g
1600	27	180	380
1602	28	180	380
1604	29	180	380
1606	30	190	440
1608	32	190	440
1610	33	190	440
1612	34	190	440
1614	35	215	750
1616	36	215	750
1618	37	215	750
1620	38	215	750
1622	41	235	1150
1624	42	235	1150
1626	46	255	1400
1628	47	255	1400
1630	50	275	1600
1632	52	275	1600
1634	54	275	1600
1636	55	300	1800
1638	56	300	1800
1640	58	300	1800
1642	60	320	2500
1644	63	320	2500
1646	65	340	3700
1648	67	340	3700
1650	70	375	4000
1652	71	375	4000
1654	75	375	4000
1656	77	375	4000
1658	80	410	6300
1660	82	410	6300
1662	85	410	6300
1664	88	445	8000
1666	90	445	8000
1668	94	445	8000
1670	95	445	8000
1672	100	485	9900
1674	105	485	16500
1678	110	570	19500
1682	115	510	19500
1684	120	545	23000

Millimeter (mm)			
Number	s mm	l mm	Δ g
1686	125	545	23000
1688	130	575	28000
1690	135	575	28000
1692	145	640	38000
1694	150	640	38000
1696	155	640	38000
American Inch (")			
Number	s inch	l inch	Wt. lbs.
1750	1 ¹ / ₁₆	7	0.84
1752	1 ¹ / ₈	7	0.84
1754	1 ³ / ₁₆	7 ¹ / ₂	0.97
1756	1 ¹ / ₄	7 ¹ / ₂	0.99
1758	1 ⁵ / ₁₆	7 ¹ / ₂	0.99
1760	1 ³ / ₈	8 ¹ / ₂	1.65
1762	1 ⁷ / ₁₆	8 ¹ / ₂	1.65
1764	1 ¹ / ₂	8 ¹ / ₂	1.65
1766	1 ⁹ / ₁₆	9 ¹ / ₄	2.54
1768	1 ⁵ / ₈	9 ¹ / ₄	2.54
1770	1 ¹¹ / ₁₆	9 ¹ / ₄	2.54
1772	1 ³ / ₄	9 ¹ / ₄	2.54
1774	1 ¹³ / ₁₆	10	3.09
1776	1 ⁷ / ₈	10	3.09
1778	2	10 ³ / ₄	3.53
1780	2 ¹ / ₁₆	10 ³ / ₄	3.53
1782	2 ¹ / ₈	10 ³ / ₄	3.53
1784	2 ³ / ₁₆	11 ³ / ₄	3.97
1786	2 ¹ / ₄	11 ³ / ₄	3.97
1788	2 ⁵ / ₁₆	11 ³ / ₄	3.97
1790	2 ³ / ₈	12 ¹ / ₂	5.51
1792	2 ⁷ / ₁₆	12 ¹ / ₂	5.51
1794	2 ¹ / ₂	12 ¹ / ₂	5.51
1796	2 ⁹ / ₁₆	13 ¹ / ₄	8.16
1798	2 ⁵ / ₈	13 ¹ / ₄	8.16
1800	2 ³ / ₄	14 ³ / ₄	8.82
1802	2 ¹³ / ₁₆	14 ³ / ₄	8.82
1804	2 ¹⁵ / ₁₆	14 ³ / ₄	8.82
1806	3	14 ³ / ₄	8.82
1808	3 ¹ / ₈	16	13.89
1810	3 ¹ / ₄	16	13.89
1812	3 ³ / ₈	16	13.89
1814	3 ¹ / ₂	17 ¹ / ₂	17.64
1816	3 ⁵ / ₈	17 ¹ / ₂	17.64
1818	3 ³ / ₄	17 ¹ / ₂	17.64
1820	3 ⁷ / ₈	19	21.85
1822	4	19	36
1824	4 ¹ / ₈	19	36
1832	4 ⁵ / ₁₆	20	43
1840	4 ⁹ / ₁₆	20	43
1844	4 ¹¹ / ₁₆	21 ¹ / ₂	50
1852	4 ¹⁵ / ₁₆	21 ¹ / ₂	50
1858	5 ¹ / ₈	22 ⁵ / ₈	62
1866	5 ³ / ₈	25 ¹ / ₄	62
1876	5 ¹¹ / ₁₆	25 ¹ / ₄	84
1886	6	25 ¹ / ₄	84

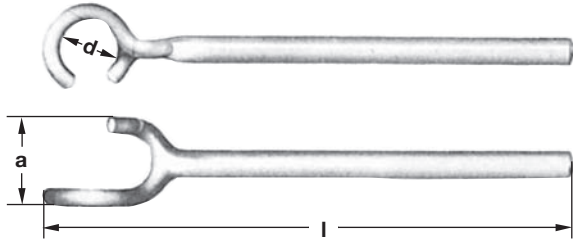

Wrench, Valve Wheel (DIN 87311)
Clé à volant
Llave Giradora de Válvulas

Number	d mm	a mm	l mm	⚖ g	d inch	a inch	l inch	Wt. lbs.
7470	36	60	370	650	1 ³ / ₈	2 ³ / ₈	14 ¹ / ₂	1.43
7472	48	80	430	1300	1 ⁷ / ₈	3 ¹ / ₈	17	2.87
7474	62	102	550	2550	2 ⁷ / ₁₆	4	21 ⁵ / ₈	5.62

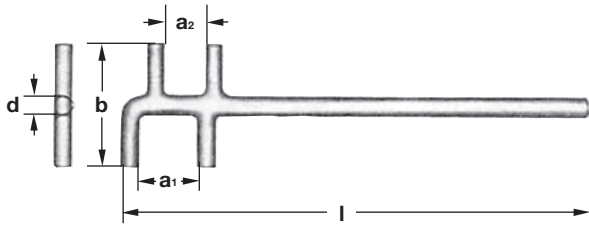

Valve Wheel Hook
Clé à valve
Gancho Girador de Válvulas

Millimeter (mm)						
Number	a1 mm	a2 mm	b mm	d mm	l mm	⚖ g
7520	40	30	113	13	500	720

American Inch (")						
Number	a1 inch	a2 inch	b inch	d inch	l inch	Wt. lbs.
7520	1 ⁹ / ₁₆	1 ³ / ₁₆	4 ⁷ / ₁₆	1/2	19 ³ / ₄	1.59

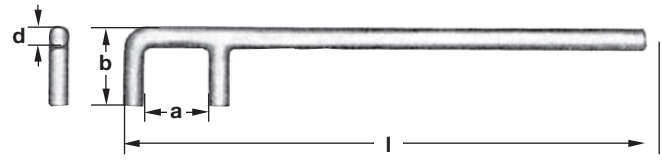

Valve Wheel Hook
Clé à valve
Gancho Girador de Válvulas

Millimeter (mm)					
Number	a mm	b mm	d mm	l mm	⚖ g
7490	30	56	13	300	350
7492	35	61	13	350	600
7494	40	72	16	400	680
7496	45	77	16	450	1110
7498	50	88	19	500	1200
7502	60	104	22	600	2000
7506	70	120	25	700	3000
7508	80	136	28	800	5300

American Inch (")					
Number	a inch	b inch	d inch	l inch	Wt. lbs.
7490	1 ³ / ₁₆	2 ³ / ₁₆	1/2	11 ³ / ₄	.77
7492	1 ³ / ₈	2 ³ / ₈	1/2	13 ³ / ₄	1.32
7494	1 ⁵ / ₈	2 ³ / ₈	5/8	15 ³ / ₄	1.50
7496	1 ³ / ₄	3	5/8	17 ³ / ₄	2.44
7498	2	3 ⁷ / ₁₆	3 ¹ / ₄	19 ³ / ₄	2.64
7502	2 ³ / ₈	4	7/8	23 ⁵ / ₈	4.41
7506	2 ³ / ₄	4 ³ / ₄	1	27 ¹ / ₂	6.61
7508	3 ¹ / ₈	5 ³ / ₈	1 ¹ / ₈	31 ¹ / ₂	11.67

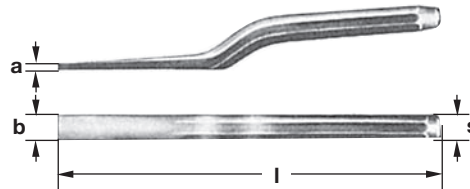

Yarning Tool
Matoir à cordes
Herramienta de Hilado

Number	a mm	b mm	s mm	l mm	⚖ g	a inch	b Inch	s inch	l inch	Wt. lbs.
7780	2	20	18	250	550	5/64	3/4	5/8	10	1.21
7782	4	20	18	250	560	5/32	3/4	5/8	10	1.23
7784	6	20	18	250	580	1/4	3/4	5/8	10	1.28
7786	8	20	18	250	600	5/16	3/4	5/8	10	1.32



AMPCO Tool Kits

- **A Tool for Every Purpose and a Kit for Any Job!**
- **Un Outil pour Chaque Usage et un Jeu D'outils pour Quel Tâche**
- **¡Una Herramienta para Cada Propósito y un Juego de Herramientas para Cualquier Trabajo!**

M-39 6 pc. Screwdriver Set

Pieces	
S-48	Std Screwdriver 9/32" Tip, 3" Blade
S-49	Std Screwdriver 5/16" Tip, 6" Blade
S-50	Std Screwdriver 25/64" Tip, 8" Blade
S-1099A	#1 Phillips Screwdriver
S-1099	#2 Phillips Screwdriver
S-1100	#3 Phillips Screwdriver

1.86 lbs. / 850 grams



M-41 7 pc. Combination Wrench Set Metric Sizes Available

Pieces	
W-601	3/8" Combination Wrench
W-611	7/16" Combination Wrench
W-621	1/2" Combination Wrench
W-631	9/16" Combination Wrench
W-641	5/8" Combination Wrench
W-661	3/4" Combination Wrench
W-671	7/8" Combination Wrench

2.46 lbs. / 1115 grams



M-42 10 pc Allen Wrench Set

Pieces	
W-1050-L	1/16" Allen Key
W-1050 R	5/64" Allen Key
W-1050 P	3/32" Allen Key
W-1050 A	1/8" Allen Key
W-1050 B	5/32" Allen Key
W-1050 C	3/16" Allen Key
W-1050 D	7/32" Allen Key
W-1050 E	1/4" Allen Key
W-1050 F	5/16" Allen Key
W-1050 G	3/8" Allen Key

.66 lbs. / 300 grams

Metric Sizes Available



M-46 4 pc Tool Kit

Pieces	
S-48	Std Screwdriver 9/32" Tip, 3" Blade
P-30	6 1/2" Combination Pliers
W-71	8" Adjustable End Wrench
CJ-1-ST	9" Crate Opener

2.22 lbs. / 1015 grams



M-47 6 pc Tool Kit

Pieces	
S-48	Std Screwdriver 9/32" Tip, 3" Blade
P-30	6 1/2" Combination Pliers
W-71	8" Adjustable End Wrench
CJ-1-ST	9" Crate Opener
S-1099	#2 Phillips Screwdriver
P-39	#10 Groove Joint Pliers

3.24 lbs. / 1480 grams



AMPCO Tool Kits



M-48 11 pc Tool Kit

Pieces	
P-31	8" Combination Pliers
B-399	Shoe Handle Brush
K-21	Putty Knife (Stiff) 1 1/4" x 3 9/16" Blade 7 3/4" OAL
K-1	Common Knife 3 1/8" Blade, 6 3/4" OAL
P-39	10" Groove Joint Pliers
S-1099	#2 Phillips Screwdriver
S-49	Std Screwdriver - 5/16" Tip, 6" Blade
H-20FG	16oz Claw Hammer with Fiberglass Handle
W-70	6" Adjustable Wrench
W-72	10" Adjustable Wrench
W-211	10" Adjustable Pipe Wrench

10.2 lbs. / 4625 grams



M-49 16 pc Tool Kit

Pieces	
W-3109	Dble End Box Wrench - 5/16" x 3/8"
W-3120	Dble End Box Wrench - 7/16" x 1/2"
W-3150	Dble End Box Wrench - 9/16" x 5/8"
W-3180	Dble End Box Wrench - 3/4" x 7/8"
S-1099	#2 Phillips Screwdriver
S-49	Std Screwdriver - 5/16" Tip, 6" Blade
W-72	10" Adjustable Wrench
P-30	6 1/2" Combination Pliers
P-31	8" Combination Pliers
P-39	10" Groove Joint Pliers
K-1	Common Knife 3 1/8" Blade, 6 3/4" OAL
K-21	Putty Knife (Stiff) 1 1/4" x 3 9/16" Blade 7 3/4" OAL
H-20FG	16oz Claw Hammer with Fiberglass Handle
W-212	14" Adjustable Pipe Wrench
B-399	Shoe Handle Brush
S-10G	Deck Scraper-2" x 12"

14.34 lbs. / 6505 grams



M-51 17 pc HAZMAT Tool Kit

Pieces	
B-399	Shoe Handle Brush
CJ-1-ST	9" Crate Opener
H-20FG	16oz Claw Hammer w/ Fiberglass Handle
K-5	Common Knife 5 3/4" Blade, 10 3/4" OAL
K-21	Putty Knife (Stiff) 1 1/4" x 3 9/16" Blade 7 3/4" OAL
P-312	12" Groove Joint Plier
P-326	7" Long Nose Pliers with Cutters
P-31	8" Combination Pliers
S-11G	Deck Scraper, 1 1/2" Blade x 15" Long
S-40	Spray Booth Scraper, 3" Blade x 9 1/4" Long
S-49	Std Screwdriver - 5/16" Tip, 6" Blade
S-1100	#3 Phillips Screwdriver
S-1144	12" Tin Snips
W-71	8" Adjustable Wrench
W-73	12" Adjustable Wrench
W-212AL	14" Pipe Wrench (Aluminum)
W-56	12" Bung Wrench (Fits 3/4" x 2")

19.94 lbs. / 9045 grams

AMPCO CUSTOM KITS
 Mix & Match...
 There is NO CATCH!